



Digital & Analog Mixers

Active & Passive Speakers

Professional Line Array Systems

Digital Processors & Amplifiers

Advanced Wireless Systems

AMERICA

Index

Mixer	DM48.20	4
	DIO24	6
	DM24.8	8
	T2208	10
	DR16.4	12
	MX Series	14
	MXi Series	16

Array System	APX Array	20
	KS Array	22
	L-ARRAY	24
	FLX5 System	26
	TD500.4DSP V2	28
	FLX3 System	30
X3 Mini Array	32	

Portable System	READY 5B / READY 6B	18
-----------------	---------------------	----

PA Audio System	MegaSys 1	34
	EVENT2K / EVENT 4K	36
	VA42.12	38
	SOHO V8 PLUS / S15	40

World Class Marketing!

INFO

www.topppro.com



CREATIVE, INSIGHTFUL, VALUABLE... **ALWAYS RELIABLE!**



Speaker	KS HD Series	42	Install PA	TMA-4150ZBT / TAP Series	66
	KS HD Subwoofers	44		TAP Series	68
	KS CS Series	46		WRS Series	70
	KS Active Subwoofers	48	Wireless	Wireless Devices	72
	KS Series	50		TMW Series	74
	ZP Series	52		Power Amplifier	TRX / TDX Series
	FORZA PLUS Series	54	LVA Series		78
	AVANTI Series	56	HVA Series		80
	X CS Series	58	Processor		DLM408 PLUS / DLM808
	STARK DSP Series	60		Digital / Analog Processors	84
	MAXX DSP Series	62		Powered Box Mixer	TPM Series
TPS Series	64				

**World Class
Representation!**

the **NAMM**[®]
show²⁴

prolight+sound

**Integrated
Systems
Europe**

infocomm



DM48.20 Technical Specifications

Microphone input	Electronically balanced
Frequency Response to Main Output	22Hz ~ 20KHz at 0dBu ±1.5dBu
Distortion (THD&N) to Main Output	<0.03% at 0dBu 1KHz
Gain	0dBu ~ 50dBu
SNR (Signal to Noise Ratio)	109dB
Maximum Input Level	+20dBu ±0.5dBu
Phantom Power (+/-3V)	+48VDC
USB stereo inputs	
Frequency Response to Main Output	22Hz ~ 15KHz
Distortion (THD&N) to Main Output	<0.1% at 0dBu 1KHz
Maximum Input Level	10dBu ±0.5dBu
Out 1-16	
Maximum Outputs Level	+20dBu ±0.5dBu
Main Outputs	
Maximum Outputs Level	+20dBu ±0.5dBu
Control Room Outputs	
Maximum Output Level	+20dBu ±0.5dBu
Noise Gate	
Threshold Range	-80dBu ~ -30dB
Attack time	0.5mS ~ 200mS
Release time	10mS~1S
Compressor	
Threshold Range	-30dBu - +20dB
Attack time	10mS ~ 150mS
Release time	10mS ~ 1S
Ratio	1:1 to Limit
Gain	0dBu - +20dB
EQ	
Low (LowPass or LowShelf)	20Hz ~ 20KHz ±(15dBu±2dBu)
Low Mid	20Hz ~ 20KHz ±(15dBu±2dBu)
High Mid	20Hz ~ 20KHz ±(15dBu±2dBu)
High (HighPass or HighShelf)	20Hz ~ 20KHz ±(15dBu±2dBu)
Digital Audio	
ADC Dynamic Range	114dB
DAC Dynamic Range	114dB
Internal Processor	32-bit , floating point
ADC, DAC bit depth	24bit
Main LCD	10.1inch (1024x600)
Channel OLED	0.96 inch (128x64)
Impedances	
Microphone input	6.8K Ohm
All output	120 Ohm
Operating free-air temperature range	0°C ~ 40°C
Storage temperature range	-20°C ~ 45°C



*Using 2 DIO24s

DIO24

Dante Digital Snake



USB

Record / Playback
to USB Key



Now with AES67
Dante
SPOKEN HERE



Dante
Optional Digital Card

Download the free
App from App Store
to control



DM48.20

NEW
MODEL



- | Up to 48 Inputs
- | 32 XLR Mic Inputs
- | 20 XLR Outputs
- | 10" Touchscreen
- | OLED Name Strips
- | 4 Multi-Effects Engines
- | 17 Motorized Faders
- | Sends On Faders
- | GEQ On Faders
- | 16 DCA Groups
- | Automix
- | Programmable User Keys
- | Programmable User Layer
- | Digital Inserts* (External Plug-in Processing)
- | USB 2-Track Record / Playback



DIO24 Technical Specifications

Microphone input	Electronically balanced
Frequency Response to Main Output	20Hz~20KHz at 0dBu ±1dB
Distortion (THD&N) to Main Output	<0.03% at 0dBu 1KHz
SNR (Signal to Noise Ratio)	108dB
Maximum Input Level	+20dBu
Phantom Power (+/-3V)	+48VDC
EIN (Input noise)	125dB
XLR outputs	
Maximum Output Level	+20dBu
System Crosstalk Adjacent Channels	
Input to Output (at +20dBu 1KHz)	-70dBu
Noise (Bus noise)	-91dBu
Digital Audio	
ADC Dynamic Range	114dB
DAC Dynamic Range	114dB
Internal Processor 32-bit	32-bit, floating point
ADC, DAC bit depth 32-bit	32-bit
Impedances	
Microphone input	6.8KΩ
Output	240Ω
Operating free-air temperature range	0°C~40°C
Storage temperature range	-20°C ~60°C



**Allows Remote Access
and Digital Gain for
DM Series Digital Mixers**



Shown with
DM48.20 Mixer



PC Control

Compatible with:



DM48.20



DM20.12



DM24.12

DIO24



24 x 12-XLR I/O
Included Dante I/O



Ethernet Switch



iPad or
Android
Tablet
Control

DM24.8 Technical Specifications

Microphone input	Electronically balanced
Frequency Response to Main Output	22Hz ~ 20KHz at 0dBu ±1.5dBu
Distortion (THD&N) to Main Output	<0.01% at 0dBu 1KHz
Gain	0dBu ~ 50dBu
SNR (Signal to Noise Ratio)	111dB
Maximum Input Level	+20dBu ±0.5dBu
Phantom Power (+/-3V)	+48VDC
Line input	Electronically balanced
Frequency Response to Main Output	22Hz ~ 22KHz at 0dBu ±1.5dBu
Distortion (THD&N) to Main Output	<0.01% at 0dBu 1KHz
Gain	-20dBu ~ +30dBu
Maximum Input Level (Gain at 0dBu)	+20dBu ±0.5dBu
USB stereo inputs	
Frequency Response to Main Output	22Hz ~ 22KHz at 0dBu ±1.5dBu
Distortion (THD&N) to Main Output	<0.02% at 0dBu 1KHz
Maximum Input Level	16dBu ±0.5dBu
Main Outputs	
Maximum Outputs Level	+20dBu ±0.5dBu
AUX SEND (XLR)	
Maximum Output Level	+20dBu ±0.5dBu
AUX SEND (1/4" TRS)	
Maximum Output Level	+20dBu ±0.5dBu
Control Room Outputs	
Maximum Output Level	+20dBu ±0.5dBu
Headphones Level	
Maximum Output Level	+15dBu ±0.5dBu
System Crosstalk	
Input to Output (at + 0dBu 1KHz)	-88dBu
Adjacent Channels (at + 0dBu 1KHz)	-87dBu
Noise (Bus noise)	
Noise Gate	-91dBu
Threshold Range	-84dBu ~ +20dB
Attack time	0.5mS ~ 200mS
Release time	10mS~1S
Compressor	
Threshold Range	-30dBu - +20dB
Attack time	10mS ~ 150mS
Release time	10mS ~ 1S
Ratio	1:1 to Limit
Gain	0dBu - +24dB
EQ	
Low (LowPass or LowShelf)	21Hz ~ 19.2KHz +/- 24dB
Low Mid	21Hz ~ 19.2KHz +/- 24dB
High Mid	21Hz ~ 19.2KHz +/- 24dB
High (HighPass or HighShelf)	21Hz ~ 19.2KHz +/- 24dB
Digital Audio	
ADC Dynamic Range	114dB
DAC Dynamic Range	114dB
Internal Processor	32-bit , floating point
ADC, DAC bit depth	24bit
Impedances	
Microphone input	6.8K Ohm
Line input	75K
Stereo input	27K
All other output	240 Ohm
Operating free-air temperature range	0°C ~ 40°C



Dante
Optional Digital Card

Download the free App from App Store to control



DM24.8

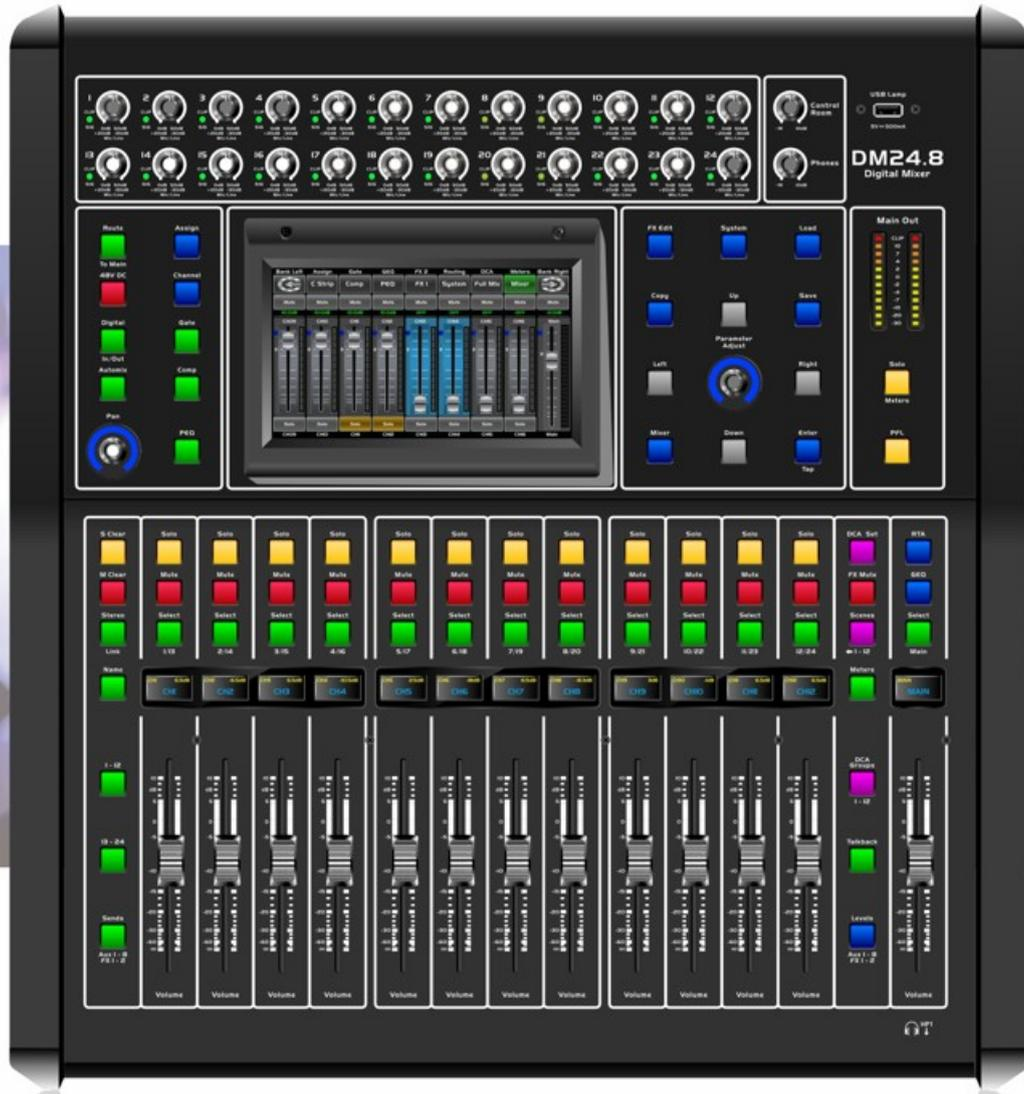

- | 24-XLR Mic Inputs
- | 8-XLR Auxiliary Outputs
- | XLR- Main Out
- | Headphones Out
- | Digital Inserts
- | 13 Motorized Multi-Use Faders
- | OLED Name Strips
- | External Plug-In Processing
- | 2 Multi-Effects Engines
- | 7" Touchscreen
- | Sends on Faders
- | 12 DCA Groups
- | Automix



T2208 Technical Specifications

Microphone input	Electronically balanced
Frequency Response to direct Output	20Hz-20KHz at 0dBu ±1.5dB
Distortion (THD&N) to Main Output	<0.01% at 0dBu 1KHz
SNR (Signal to Noise Ratio)	104dB
Maximum Input Level	+22dBu
Phantom Power (+/-3V)	+48VDC
Line inputs	Unbalanced
Frequency Response to direct Output	20Hz-20KHz at 0dBu ±1.5dB
Distortion (THD&N) to Main Output	<0.01 % at 0dBu 1KHz
Gain	-15dBu ~ +35dBu
Maximum Input Level (Gain at 0dBu)	+20dBu
17-18/19-20 stereo inputs	Balanced (2 stereo pair)
Frequency Response to Main Output	20Hz~20KHz at +4dBu ±1.5dB
Distortion (THD&N) to Main Output	<0.01 % at 0dBu 1KHz
Gain	-∞ to +10dBu
Maximum Input Level	+22dBu
Tape L/R input/USB	20Hz-20KHz at +4dBu
Frequency Response to Main Output	20Hz-20KHz at +4dBu ±1.5dB
Distortion (THD&N) to Main Output	<0.01 % at 0dBu 1KHz
Gain	-∞ to +10dBu
Maximum Input Level	+22dBu
Main Outputs	
Maximum Output Level	+20dBu
AUX1-8 Outputs	
Maximum Output Level	+20dBu
Control Room Outputs	
Maximum Output Level	+20dBu
System Crosstalk	
Input to Output (at +4dBu 1 KHz)	-87dBu
Adjacent Channels (at +4dBu 1 KHz)	-86dBu
Noise (Bus noise)	-90dBu
Noise Gate	
Threshold Range	-84dBu - 0dB
Attack time	0.5mS ~ 200mS
Release time	5mS ~ 2S
Compressor	
Threshold Range	-30dBu - +20dB
Attack time	10mS ~ 150mS
Release time	10mS-1S
Ratio	1 :1 to 24:1
Gain	0dBu - +24dB
EQ	
Low (LowPass or LowShelf)	21Hz~19.2KHz ±24dB
Low Mid	21Hz~19.2KHz ±24dB
High Mid	21Hz~19.2KHz ±24dB
High (HighPass or HighShelf)	21Hz~19.2KHz ±24dB
Digital Audio	
ADC Dynamic Range	114dB
DAC Dynamic Range	114dB
Internal Processor	32-bit, floating point
ADC, DAC bit depth	24bit
Impedances	
Microphone input	1.4K Ohm
Channel Isert return	2.5K Ohm
All other inputs	10K Ohm or greater
Tape out	1K Ohm
All other output	120 Ohm
Operating free-air temperature range	0°C~40°C

Easy Install Matrix



Save, Lock, Restore!

6 Programmable Groups
10 Programmable Zones



Dante Optional Digital Card

Download the free
App from App Store
to control



T2208



- | 16-XLR Mic Inputs
- | 8-XLR Auxiliary Outputs
- | XLR- Main Out
- | Control Room Out
- | Headphone Out
- | Digital Inserts
- | External Plug-In Processing
- | 2 Multi-Effects Engines
- | 7" Touchscreen
- | 1 Motorized Multi-Use Fader
- | 6 DCA Groups
- | AutoMix
- | Talkback
- | Photo Capture



DR16.4 Technical Specifications

Main Out L/R	0dB (Balanced)
Frequency Response to Main Output	20Hz ~ 20KHz at 0dBu ±1.5dBu
Distortion (THD&N) to Main Output	<0.01% at 0dBu 1KHz
Gain	0dBu ~ 50dBu
SNR (Signal to Noise Ratio)	108dB
Maximum Input Level	+20dBu ±0.5dBu
Phantom Power (+/-3V)	+48VDC ±3V
Line input	Main Out L/R = 0dB (Balanced)
Frequency Response to Main Output	20Hz ~ 20KHz at 0dBu ±1.5dBu
Distortion (THD&N) to Main Output	<0.01% at 0dBu 1KHz
Gain	-20dBu ~ +30dBu
Maximum Input Level	+20dBu
AUX 1 ~ 2 input	Balanced (2 stereo pair)
Frequency Response to Main Output	20Hz ~ 20KHz at 0dBu ±1.5dBu
Distortion (THD&N) to Main Output	<0.01% at 0dBu 1KHz
LEVEL Gains	-∞ to +10dBu
Maximum Input Level	+20dBu
Main Outputs	
Maximum Outputs Level	+20dBu
AUX 1 ~ 8 Outputs	
Maximum Output Level	+20dBu
Tape Outputs	
Maximum Output Level	+20dBu
Control Room Outputs	
Maximum Output Level	+20dBu
HP1 Level	
Maximum Output Level	+15dB
Input to Output (at + 0dBu 1KHz)	-88dBu
Adjacent Channels (at + 0dBu 1KHz)	-85dBu
Noise (Bus noise)	-91dBu
Noise Gate	
Threshold Range	-84dBu ~ +20dB
Attack time	0.5mS ~ 200mS
Release time	10mS~1S
Compressor	
Threshold Range	-30dBu - +20dB
Attack time	10mS ~ 150mS
Release time	10mS ~ 1S
Ratio	1:1 to 10:1
Gain	0dBu - +24dB
EQ	
Low (LowPass or LowShelf)	21Hz ~ 19.2KHz +/- 24dB
Low Mid	21Hz ~ 19.2KHz +/- 24dB
High Mid	21Hz ~ 19.2KHz +/- 24dB
High (HighPass or HighShelf)	21Hz ~ 19.2KHz +/- 24dB
Digital Audio	
ADC Dynamic Range	114dB
DAC Dynamic Range	114dB
Internal Processor	32-bit , floating point
ADC, DAC bit depth	24bit
Impedances	
Microphone input	6.8K Ohm
Line input	75K
Stereo input	27K
All other output	240 Ohm
Operating free-air temperature range	0°C ~ 40°C



... iPad support available
Not Required!



Dante
Optional Digital Card

Download the free
App from App Store
to control





DR16.4



A professional DANTE digital rack that... **does not** require wifi to mix!

Great for Education Halls, Houses of Worship, Entertainment, Corporate Events

Affordable & Easy to Integrate!

- | 16 Total Inputs plus digital I/O
- | 10 XLR High-Gain Mic Pres
- | XLR- Main Out
- | 6 Line Inputs (linked) 3 Stereo Channels
- | 2 Auxiliary Outs / Pre / Post Main
- | Solo Bus with separate Output
- | Multi-Effects Engine
- | All Inputs: Gate / Comp / PEQ
- | All Outputs: Comp / PEQ / GEQ
- | Ducker
- | Feedback Control
- | Automix
- | iPad Remote Control



MX Series Technical Specifications

	MX.8	MX.12	MX.16	MX.20
Mono MIC channel	4 MIC Channel (XLR+TRS)		8 MIC Channel (XLR+TRS)	12 MIC Channel (XLR+TRS)
	2 HI-Z Channel with switch		2 HI-Z Channel with switch	
	48V Phantom for XLR in; lowcut switch and one knob compressor;			
	3-band EQ	3-band EQ with sweepable MID; peak level display LED		
	1FX Send for internal effect and output	GAIN for input; AUX1 and 2 knob with PRE / POST switch		
		AUX3 and 4 knob post for external and internal effect		
Pan and level knob	ON switch and PAN knob; SUB1/2, SUB3/4, main bus send switch			
Stereo MIC channel	PFL switch; 60mm level fader			
	2 MIC stereo channel (XLR+TRS); 48V phantom for XLR in			
	Gain for input; lowcut for MIC input; 3-band EQ			
	AUX1 PRE and AUX2 with PRE / Post switch			
	AUX3 and 4 Post for external and internal effect			
	ON switch and PAN knob; peak level display LED			
SUB1/2, SUB3/4, main bus send switch				
PFL switch; 60mm level fader				
Stereo channel	2 Stereo Channel (TRS);			
	2-Band EQ	3-Band EQ		
	1FX Send for internal effect and output	AUX1 PRE and AUX2 with PRE / POST switch		
		AUX3 and 4 POST for external and internal Effect		
		ON switch and PAN knob; peak level display LED		
Bal and level knob	SUB1/2, SUB3/4, main bus send switch			
Monitor	PFL switch; 60mm level fader			
Monitor	Monitor and phones level control knob with source select			
Display	4V level display for main	12V level display for monitor		
Main	Main level display for main	AUX1-4 send knob		
		60mm SUB1-2 and 3-4 level fader with to main switch and ON switch		
		60mm MAIN level fader ON switch		
Output	TRS and XLR for Main Out; TRS for FX Send, Monitor out; Stereo TRS for Phones			
	AUX Send	AUX Send, SUB Out		
DFX	24 effects with adjustable parameters; 128x64 LCD for parameter display			
	Mute switch and Level Control knob	Mute switch; foot SW; FX to AUX1-3 control knob; SUB1/2, SUB3/4		
		Main bus send switch; 60mm level fader		
USB	USB Record for main out			
	Playback for CH5/6	Playback for CH9/10	Playback for CH13/14	Playback for CH17/18
MP3 Player	Record for Main out			
	Playback for CH7/8	Playback for CH11/12	Playback for CH15/16	Playback for CH19/20
BT	BT5.0 bluetooth player			
Power supply	external power supply	Internal switch power for 100-240V voltage		
Dimensions (HxWxD)	55 x 282 x 296 mm	111 x 396 x 439 mm	111 x 510 x 439 mm	111 x 620 x 439 mm
	2.17" x 11.10" x 11.65"	4.37" x 15.59" x 17.28"	4.37" x 20.08" x 17.28"	4.37" x 24.41" x 17.28"
Net Weight	2.3 kg / 5.07 lbs	6 kg / 13.23 lbs	7.7 kg / 16.98 lbs	9.4 kg / 20.72 lbs



MX Series

NEW
MODEL



- | XLR MIC/Line inputs
- | 2 Stereo Line inputs
- | 2 Subgroups
- | RCA Tape inputs / outputs
- | 3-band EQ

- | Parametric Mid Freq.
- | AUX send per channel
- | FX Send Per Channel
- | 60mm Faders
- | Phantom Power

- | Headphone output
- | Control Room Out
- | 24-bit Digital Effect
- | 24 effects with parameters
- | Built-in MP3/BT player



MX.8

MX.12

MX.16

MX.20

MXi Series Technical Specifications

MXi Series

MXi.3BT	MXi.5
1 Precision mono input Mic/Line with combo jack	5 Input Mixer
Stereo Input	1 Mic/Line input
Monitor Output	2 Stereo Line inputs
RCA Tape inputs/ outputs	RCA Tape inputs/ outputs
2 band EQ	2 band EQ
Monitor Output	Headphone output
Bluetooth	-

MXi.6	MXi.6USB	MXi.6FX
6 Input Mixer	6 Input Mixer	6 Input Mixer
2 MIC/Line inputs	2 MIC/Line inputs	2 MIC/Line inputs
2 Stereo Line Inputs	2 Stereo Line Inputs	2 Stereo Line Inputs
-	USB i/o	24-bit Digital FX Processor
-	-	100 Presets

Common Spec.

RCA Tape inputs/ outputs, 3-band EQ, AUX send per channel, Phantom Power, Headphone output, Control Room Out

MXi.10	MXi.10USB
10 Input Mixer	10 Input Mixer
2 MIC/Line inputs	2 MIC/Line inputs
4 Stereo Line Inputs	4 Stereo Line Inputs
-	USB i/o

Common Spec.

RCA Tape inputs/ outputs, 3-band EQ, AUX send per channel, Phantom Power, Headphone output, Control Room Out, Main Master Fader

MXi.12	MXi.12USB	MXi.12FX
12 Input Mixer	12 Input Mixer	12 Input Mixer
4 MIC/Line inputs	4 MIC/Line inputs	4 MIC/Line inputs
4 Stereo Line Inputs	4 Stereo Line Inputs	4 Stereo Line Inputs
-	USB i/o	24-bit Digital FX Processor
-	-	100 Presets

Common Spec.

RCA Tape inputs/ outputs, 3-band EQ, AUX send per channel, Phantom Power, Headphone output, Control Room Out, Main Master Fader

MXi CFX Series

MXi.1222CFX	MXi.1422CFX	MXi.1622CFX	MXi.2422CFX
12 Input Mixer	14 Input Mixer	16 Input Mixer	24 Input Mixer
6 MIC/Line inputs	8 MIC/Line inputs	10 MIC/Line inputs	12 MIC/Line inputs

Common Spec.

2 Stereo Line inputs, 2 Subgroups, RCA Tape inputs / outputs, 3-band EQ, Parametric Mid Freq., AUX send per channel, FX Send Per Channel, 60mm Faders, Phantom Power, Headphone output, Control Room Out, 24-bit Digital Effect, 100 Presets, Built-in MP3 player

MXi Series



MXi.3BT



MXi.5



MXi.6USB



MXi.6FX



MXi.10USB



MXi.12USB



MXi.12FX



MXi CFX Series



- | XLR MIC/Line inputs
- | 2 Stereo Line inputs
- | 2 Subgroups
- | RCA Tape inputs / outputs
- | 3-band EQ
- | Parametric Mid Freq.
- | AUX send per channel
- | FX Send Per Channel
- | 60mm Faders
- | Phantom Power
- | Headphone output
- | Control Room Out
- | 24-bit Digital Effect
- | 100 Presets
- | Built-in MP3 player



MXi.1222CFX



MXi.1422CFX



MXi.1622CFX



MXi.2422CFX

Ready 5B & 6B Technical Specifications

	READY 5B	READY 6B
System Type	Portable Sound System with Bluetooth	2-Way Active All-in-one PA system with Bluetooth
Transducer Low	5.25" Woofer	6.5" Woofer
Transducer High	-	1" Neodymium driver
Frequency Response (-6dB)	80Hz - 16KHz	70Hz - 16KHz
Crossover Frequency	-	1.9KHz
Max SPL	113dB Max	116dB Max
AMP Power Output	Class-D MONO 40W RMS	Bi-amp, Class-D 100W RMS (LF 90W / HF 10W)
Input	CH1 MIC: -35dBu (±1dBu) CH2 LINE: 0dBu (±1dBu)	
Sensitivity	CH1 LINE: 0dBu (±1dBu) CH2 Hi-Z: -35dBu (±1dBu) / AUX: -10dBu (±1dBu)	
Equalizer Controls	BASS: ±10dB (at 100Hz) / HIGH: ±10dBu (at 10KHz)	
External	Master Volume; MIC & LINE Switch; Hi-Z & LINE AUX each Volume	
Controls	Controls; Voice priority Switch; Power Indicators; Recharged Indicators; Battery Level Indicators	
Connectors	1 x XLR / 6.3 mm jack combo line / Mic input with 2 bands EQ 1 x 6.3 mm jack line / Hi-Z input with 2 bands EQ 1 x 3.5mm stereo jack input / 1 x 6.3 mm jack line mix output	
Voice Priority	-	MIC 1 and Wireless
Battery charge time	At least 4 hours	
Battery use time	More than 5 hours (Regular Play)	More than 6 hours (Regular Play)
Wireless Frequency band	UHF (470-900) MHz Dependent on applicable country regulations	
Built-in player	MP3 & Bluetooth	
Enclosure Construction	Plastic cabinet, Trapezoidal, Metal grille, plastic handle.	
Mounting	20mm standard pole mount	35mm standard pole-mount
Power Supply	AC-DC power adaptor 24V 2.5A / Battery:14.8V(lithium)	AC: 100V/110-240V / Battery: 25.9V(lithium)
Dimensions (LxWxH)	258 x 192 x 211 mm / 10.16" x 7.56" x 8.31"	265 x 240 x 323 mm / 10.43" x 9.45" x 12.72"
Net weight	3.4 Kg / 7.50 lbs	5.8 Kg / 12.79 lbs
Volume	1.09CFT	1.85CFT

BT/MP3 Module



Floor Monitor



Tripod
(not included)
(optional)



Ready 6 UHF Receiver Module



Ready 5 UHF Receiver Module



Tilt Back

Ready 5B & 6B

NEW
MODEL



Ready 5B
3Ch Mixer
Wireless Option

Ready 6B
3Ch Mixer w/ Reverb Effect
2 EQ Bands
Wireless Option

MAXHEB
POWER MODULE *Optimum Headroom & SPL*

NEODYMIUM
ND
DRIVER

Hi-Def
COMPONENTS



Wireless
Microphones:



TMW U1.100P



R6 HMT



5.25"
WOOFER

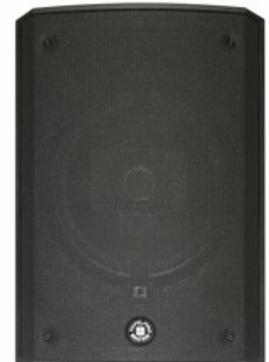

6.5"
WOOFER

APX Array Technical Specifications

APX 28HA Satellite

System Type	2-way full range, Active Array Element
Power Rating	800W Continuous / Bi-AMP (Class D-650W LF, Class AB-150W HF) / 3200W Peak
Speaker	2 x 1" Neo Driver, 1.75" V.C., 2 x 8" Celestion Woofer
Frequency Response (±3dB)	70Hz - 19kHz
MAX SPL @ 1m	121dB (continuous) / 127dB (peak)
Crossover (MID-High)	1.8 kHz
Dispersion (-6dB)	110° Horizontal / 10° Vertical
Cooling	Passive Cooling + Inside Fan
Input Connector	XLR In / Link / DSP Module with RJ45 Date In & Link
Controls	9 User Presets
DSP Processor	32 bit, 24bit/48kHz AD/DA, Digital Volume Control
Electronic Protections	Thermal / Convection-Fan / Overload / Digital Limiter / Compressor
Mains Connector	Neutrik PowerCON Connector In & Out
Power Supply	Auto-Range 100V-120V/220V-240V 50Hz/60Hz Switch mode
Enclosure	18mm Birch Plywood, Resistant Black Paint, 1.5T Metal Grille with Foam, Two Handles on
Construction	Each Side, Water Resistant Coating
Mounting	3-point Suspension, Horizontal Trapezoid 2 x 7.5°, 3 configuration styles (Small, Stack & Array)
Accessories	Flybar / Adaptor / Ground stacking bar / Flying pin / DSP control center
Dimensions (HxWxD)	556 x 388 x 753 mm / 21.89" x 15.26" x 29.65"
Net Weight	22.5 kg / 49.6 lbs

Also available in PASSIVE version

APX 18SA Subwoofer

System Type	Active Subwoofer
Power Rating	Class D 1500W RMS, 3000W Program
Speaker	1 x 18" celestion woofer, 4" Voice Coil
Frequency Response (±3dB)	30 z - 120Hz
Max SPL @ 1m	136dB (peak)
Cooling	Passive Cooling + Inside Fan
Input Connector	XLR In / Link / DSP Module with RJ45 Date In & Link
External Controls	9 Preset
DSP Processor	32 bit, 24bit/48kHz Audio conversion AD/DA, Digital Volume Control
Electronic Protections	Thermal / Convection-Fan / Overload / Digital Limiter / Compressor
Mains Connector	Neutrik PowerCON Connector In & Link
Power Supply	Auto-Range 100V-120V/220V-240V 50Hz/60Hz Switch mode
Enclosure	18mm Birch Plywood, Resistant Black Paint, 1.5T Metal Grille with Foam,
Construction	Rubber Feet, Two Handles on Each Side, Water Resistant Coating
Mounting	One Metal M20 Pole-mount, Four-point Suspension, Three configuration styles (Small, Stack & Array)
Accessories	Flybar / Adaptor / Ground stacking bar / Flying pin / DSP control center
Dimensions (HxWxD)	812 x 750 x 778mm / 31.97" x 29.53" x 30.63"
Net Weight	58.5 Kg / 128.97 lbs

CL-4

Control hub, 4 RC-Net ports, RS-485 57600BPS, control via PC software for APX series Line Array.

Subwoofer	3000W	136dB
Satellite	1600W	127dB

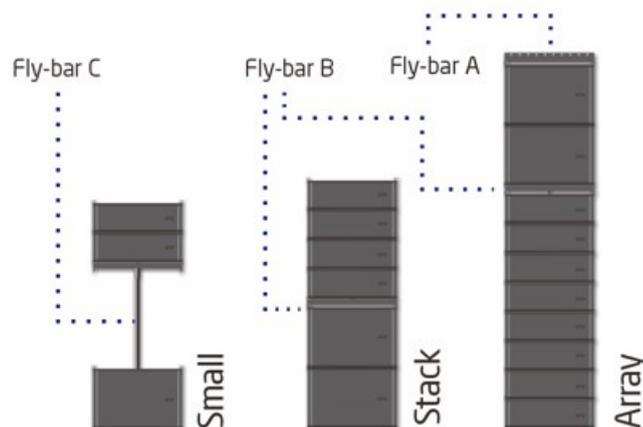

APX Array System

Professional
Concert Level
Line Array System



4 RC-Net Ports
RS485 = 57600 BPS
Control Via PC software

KS Array Technical Specifications

KS T28A

System Type	2-Way Active Vented Speaker with DSP
Transducer Low	2 x 8" Woofer, 2" Voice Coil
Transducer High	2 x 1" Titanium diaphragm, Neodymium magnet, 1.4" Voice Coil
Coverage Horizontal	100° nominal, single unit
Coverage Vertical	7.5° variable with array configuration
Frequency Response (-6dB)	65Hz - 20KHz
Crossover Frequency	At 2.0KHz with 24dB filter slope, DSP process
Max SPL	129dB Max.
AMP Power Output	800W Continus, Bi-AMP (Class D-650W LF, Class AB-150W HF), 1600W Peak
Input Connector	Line in -Combo / Link-XLR
DSP Presets	Flat / HF +3dB / User (Custom Sound)
Line Input	Combo Connector -6dBu
External Controls	Volume Control / Neutrik POWER CON® connector (Grey) offers linking the mains power supply power display with green LED / Clip Limiter with Red LED / IP Control Module (Opt.)
Electronic Protections	Thermal / Convection-Fan / Overload / Digital Lim. / Compressor
Power Supply	Neutrik POWER CON® connector, 110-120V / 220-240V~50/60Hz Switch mode
Suspension/Mounting:	Integrated hardware for suspension in Line Array, dual pole socket, two handles
Enclosure Construction	18mm calibrated plywood, black painted finish, 1.2T metal grille, power coating with internal foam
Dimensions (HxWxD)	272 x 692 x 424 mm / 10.71" x 27.24" x 16.69"
Net Weight	29.1 Kg / 64.15 lbs

KS LT118A SUB

System Type	Active Subwoofer
Power Rating	1500W Continuous Class D, 3000W PROGRAM, 6000W PEAK
Transducer Low	18" Woofer, 4" Voice Coil
Max SPL	132 dB
Frequency Response (-6dB)	38Hz to 120Hz
Crossover Frequency	LOW pass band type 24dB/oct
Connectors	Input: A and B XLR-F / High Pass and Full Range: A and B XLR-M
External Controls	Volume / DSP Processing / Signal Limit LED / Power ON with Green LED / LAN / Phase / Stereo or Mono
Electronic Protections	Thermal / Convection-Fan / Overload / Limit / Compressor
Power Supply	Neutrik POWER CON® connector, 110-240V~50/60Hz Switch mode
Suspension / Mounting	Integrated hardware for suspension in Line Array, One metal standard pole-mount, four handles
Enclosure Construction	Plywood cabinet, resistant black paint, metal grille with black foam, rubber feet
Dimensions (HxWxD)	620 x 692 x 713 mm / 24.41" x 27.24" x 28.07"
Net weight	74 Kg / 163.14 lbs

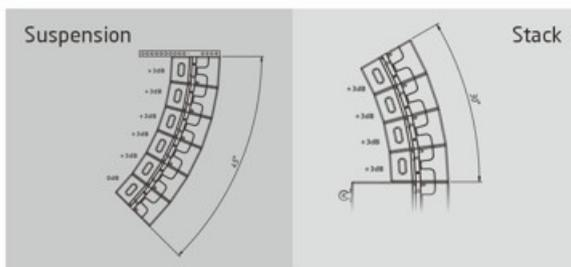

T-Array
FB-1
Fly Bar

KS Array System



Easy-Install



MAXHEB
POWER MODULE *Optimum Headroom & SPL*



Download the free App from App Store to control



L-ARRAY Technical Specifications

L-ARRAY 28H

System Type	8" 2-way Passive System
Output Power	400W Continuous / 800W Program / 1600W Peak
Maximum SPL @ 1m	129dB Max.
Frequency Response	60Hz-20KHz (-10dB)
Impedance	8 Ohm
Transducer Low	2 x 8" Woofer, 2" Voice Coil
Transducer High	2 x 1" Neodymium Compression Driver, 1.35" Voice coil
Crossover Frequency	1.5KHz
Dispersion (-6dB)	110° Horizontal, 15° Vertical
Attachment Points	Adjustable Rigging System, Vertical Splay Adjustable in 2.0° Increments from 0°-12°
Connectors	2 x SPK4 Style / HF:0dB/+3dB Switch / Passive-Bi-AMP Switch
Enclosure Construction	Polypropylene Enclosure with side handles, Steel Grille with foam
Fittings information	Steel Stirrup Material, 4 Flying Points
Dimensions (HxWxD)	262 x 572 x 420mm / 10.32" x 22.52" x 16.54"
Net Weight	17.5 Kg / 38.58 lbs

L-ARRAY 18S

System Type	18" Passive Vented Subwoofer
Output Power	750W Continuous / 1500W Program / 3000W Peak
Maximum SPL @ 1m	135dB Max.
Frequency Response	35Hz-150Hz (-10dB)
Impedance	8 Ohm
Transducer	18" Ferrite Woofer, 4" Voice Coil
Connectors	2 x SPK4 Style
Enclosure Construction	Plywood Cabinet, Resistant Black Paint, Metal Grille with foam, Rubber feet, 2 x each side
Mounting	One metal standard Pole-mount
Dimensions (HxWxD)	572 x 620 x 713 mm / 22.52" x 24.4" x 28.1"
Net Weight	62.8 Kg / 138.45 lbs

L-ARRAY 28H
Front View



L-ARRAY 28H
Rear View

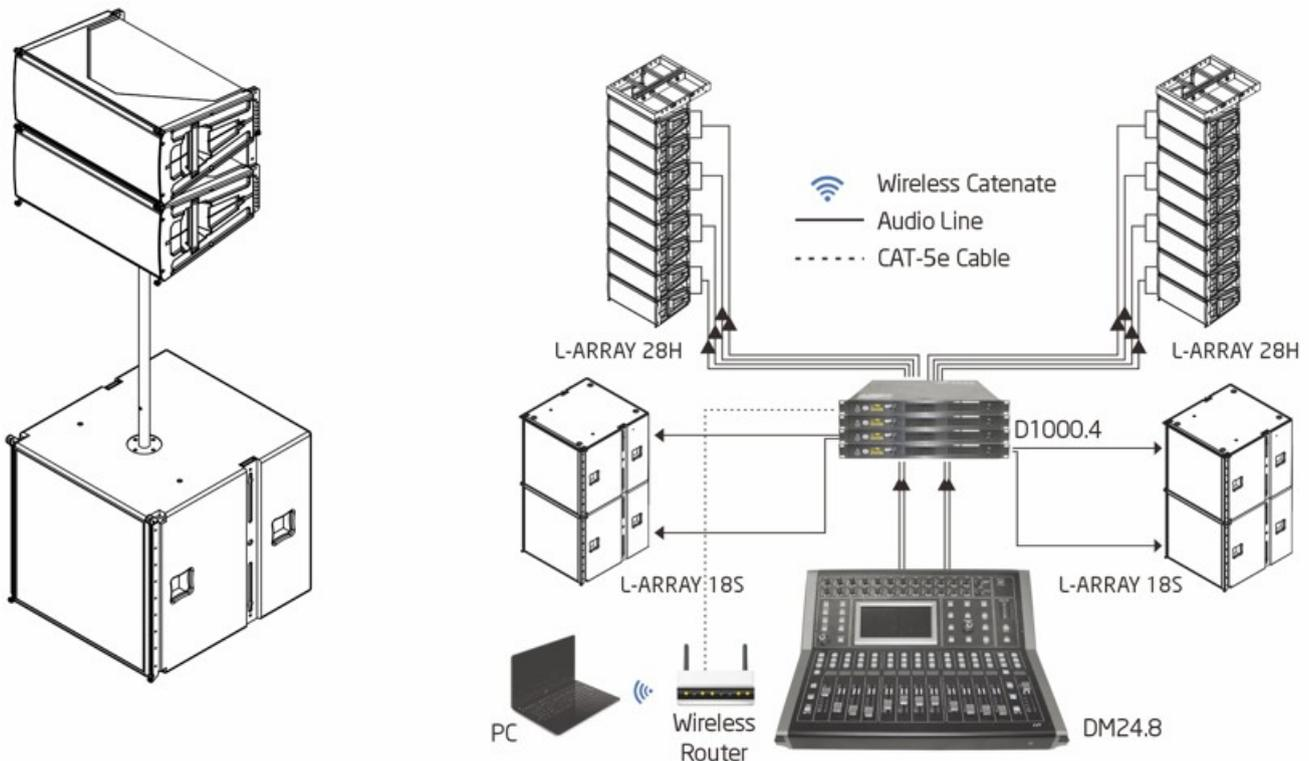

L-Array System

**BEST
SELLER**

3000W **CE**
PEAK POWER APPROVED

4 x L-ARRAY 28H
Passive Satellites
Dual 8" Woofers,
2 x 1.35" Tweeter

2 x L-ARRAY 18S
Passive Satellites
Dual 8" Woofers,
2 x 1.35" Tweeter



D1000.4
Amplifier with DSP



MAXHEB
POWER MODULE *Optimum Headroom & SPL*



2 x L-ARRAY 18S
Subwoofer 18" Passive



2 x L-ARRAY 18S
Subwoofer 18" Passive

FLX5 Technical Specifications

FLX5

System Type	5" 2-way Passive System
Output Power	120W Continuous, 240W Program
Sensitivity (1W/1M)	95dB
Maximum SPL @ 1m	115.5dB Max. (calculated)
Frequency Response	90Hz-20kHz (-10dB)
Impedance	8 ohms
Transducer Low	2 x 5" Woofer, 1.18" (30mm) Voice Coil
Transducer High	1 x 1" Tweeter, 1" (25mm) Voice Coil
Crossover Frequency	2.0kHz Passive
Dispersion (-6dB)	100° Horizontal, 12° Vertical (one module)
Attachment Points	Adjustable Rigging System, Vertical Splay Adjustable in 1.5° Increments from 0°-12°
Connectors	2 x SPK4 Style
Enclosure Construction	Polypropylene enclosure with side handles, steel Grille with foam, Steel Stirrup Material, 3 Flying Points
Dimensions (HxWxD)	161 x 430 x 304 mm / 6.34" x 16.93" x 11.97"
Weight	8 kg / 17.64 lbs

TD500.4 DSP V2

Stereo Mode	4 ohms (RMS)	500W x 4
(Both Channels Drive)	8 ohms (RMS)	250W x 4
Bridge Mono Mode	8 ohms (RMS)	1000W x 2
Input Sensitivity (Limit Off)	0.9-1.1V (0+/-1dBv)	
Input Impedance	20k ohms balanced or 10k Ohms unbalanced	
Frequency Response	20Hz ~ 20KHz (+0/-1dB) (at 10dB Rated Output Power 8 ohms)	
Voltage Gain	34+/- 0.5dB	
THD+N	<0.15% (Ref.1K 1/8 Rated Power, A-Weighted)	
S/N rate	>95dB (Ref. Rated Power, A-Weighted)	
Crosstalk	>50dB (Below Rated Power)	
Damping Factor	>180 (1K 8 ohms)	
Power/Output Circuitry	Switching Power Class D	
Protections	Full short circuit, open circuit, thermal, ultrasonic, and RF protection, stable into reactive or mismatched loads, turn ON/OFF, muting, tried crowbar.	
Controls	Encoder	
Indicators	Indicators OLED Display	
Connectors	INPUT: Active balanced XLR / OUTPUT: Speak-on jacks	
Power Supply	110V-120V or 220V-240V AC 50/60 Hz ±10%	
Dimensions (HxWxD)	44 x 483 x 460 mm / 1.73" x 19.02" x 18.11"	
Weight	8.0 kg / 17.64 lbs	



FLX5
Front View



FLX5
Rear View

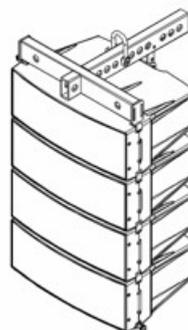

Array bracket

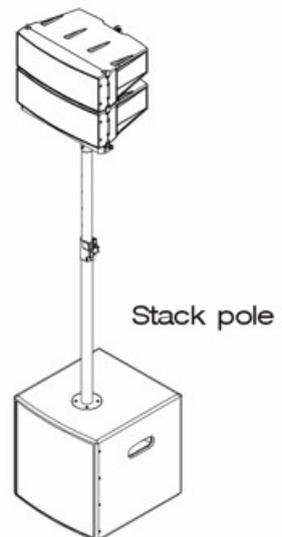

Stack pole

FLX5 Array System



4 x FLX5
Passive Satellites
Dual 5" Woofers,

4000W **CE**
PEAK POWER APPROVED

4 x FLX5
Passive Satellites
Dual 5" Woofers,



TD500.4DSP V2
Amplifier with DSP



1 x SOHO S15FLX

MAXHED
POWER MODULE *Optimum Headroom & SPL*

1 x SOHO S15FLX



TD 500.4DSP V2 Technical Specifications

Stereo Mode	4 Ohm (RMS)	500W x 4
(Both Channels Drive)	8 Ohm (RMS)	250W x 4
Bridge Mono Mode	8 Ohm (RMS)	1000W x 2
Input Sensitivity	0.9-1.1V (0+/-1dBv) (Limit Off)	
Input Impedance	20K Ohm balanced or 10K Ohm unbalanced	
Frequency Response	20Hz ~ 20KHz (+0/-1dB) (at 10dB Rated Output Power 8 Ohm)	
Voltage Gain	34+/- 0.5dB	
THD+N	<0.15% (Ref.1K 1/8 Rated Power, A-Weighted)	
S/N rate	>95dB (Ref. Rated Power, A-Weighted)	
Crosstalk	>50dB (Below Rated Power)	
Damping Factor	>180 (1K 8 Ohm)	
Power/Output Circuitry	Switching Power Class D	
Protections	Full short circuit, open circuit, thermal, ultrasonic, and RF protection, stable into reactive or mismatched loads, turn ON/OFF, muting, tried crowbar. Encoder	
Controls	OLED Display	
Indicators	INPUT: Active bala. XLR / OUTPUT: Speak-on jacks	
Connectors	110V-120V or 220V-240V AC 50/60 Hz	
Power Supply	44 x 483 x 290mm / 1.73" x 19.02" x 11.42"	
Dimensions (HxWxD)	6.0 Kg / 13.23 lbs	
Net Weight		



Versatile Active Processor

TD500.4DSP V2

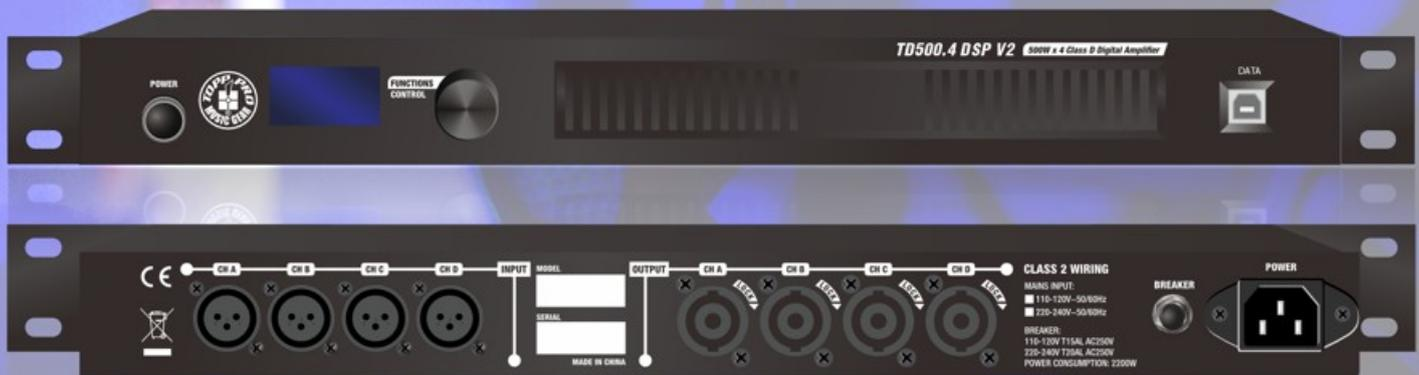

Ideal for using with **SWIFT 25 / FLX3 / X3** systems



4 x 500W
2 x 500W
2 x 1000W



Control
Everything
Better!



FLX3 Technical Specifications

FLX3

System Type	3" 2-way Passive System
Output Power	40W Continuous / 80W Program
Sensitivity (1W/1M)	90dB
Maximum SPL @ 1m	106dB Max.
Frequency Response	100Hz-20KHz (-10dB)
Impedance	8 Ohm
Transducer Low	2 x 3" Woofer, 0.75" Voice Coil
Transducer High	3 x Ø13mm V.C. Neodymium Tweeter
Crossover Frequency	2.5KHz
Dispersion (-6dB)	100° Horizontal, 30° Vertical (one module)
Attachment	Adjustable Rigging System, Vertical Splay
Points	Adjustable in 0°-1.5°-3.0°-4.5°-6.0°-8.0°-10.0°
Connectors	Increments from 0°- 10° Parallel or Series Ø6.3mm Socket / Selection Switch
Enclosure	Polypropylene Enclosure, steel Metal Grille
Construction	with foam, Steel Stirrup Material, 3 Flying Points
Dimensions (HxWxD)	124 x 265 x 195 mm / 4.88" x 10.43" x 7.68"
Net Weight	3.2 Kg / 7.06 lbs

SOHO S12P

System Type	12" Passive Subwoofer Speaker
Output Power	150W Continuous / 300W Program / 600W Peak
Sensitivity	122dB Continuous / 125dB Peak
Frequency Response	45Hz-2.8KHz (-10dB)
Impedance	4 Ohm
Transducer	12" Ferrite Woofer,
Low	2.55" Voice Coil
Connectors	4 Pin Terminal Block and 2 x NL-4 Speakon Parallel Socket
Enclosure	Plywood Cabinet, Resistant Black
Construction	Paint, Metal Grille
Mounting	One metal standard Pole-mount
Dimensions (HxWxD)	500 x 350 x 542 mm / 19.69" x 13.78" x 21.34"
Net Weight	20.10 Kg / 44.31 lbs

FLX3
Front View



FLX3
Rear View

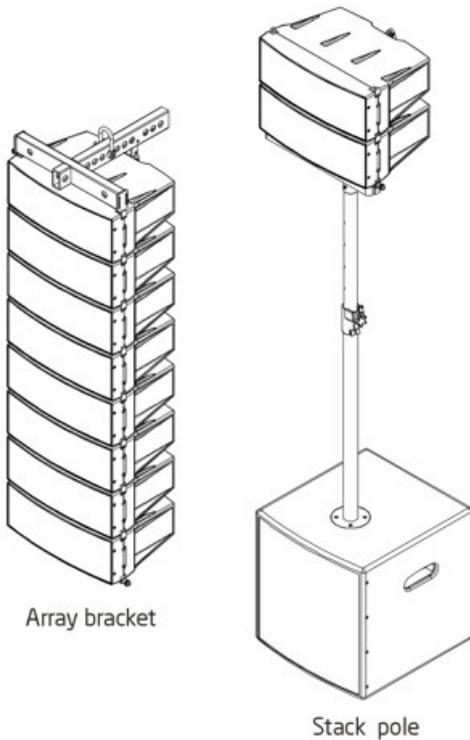

Array bracket

Stack pole

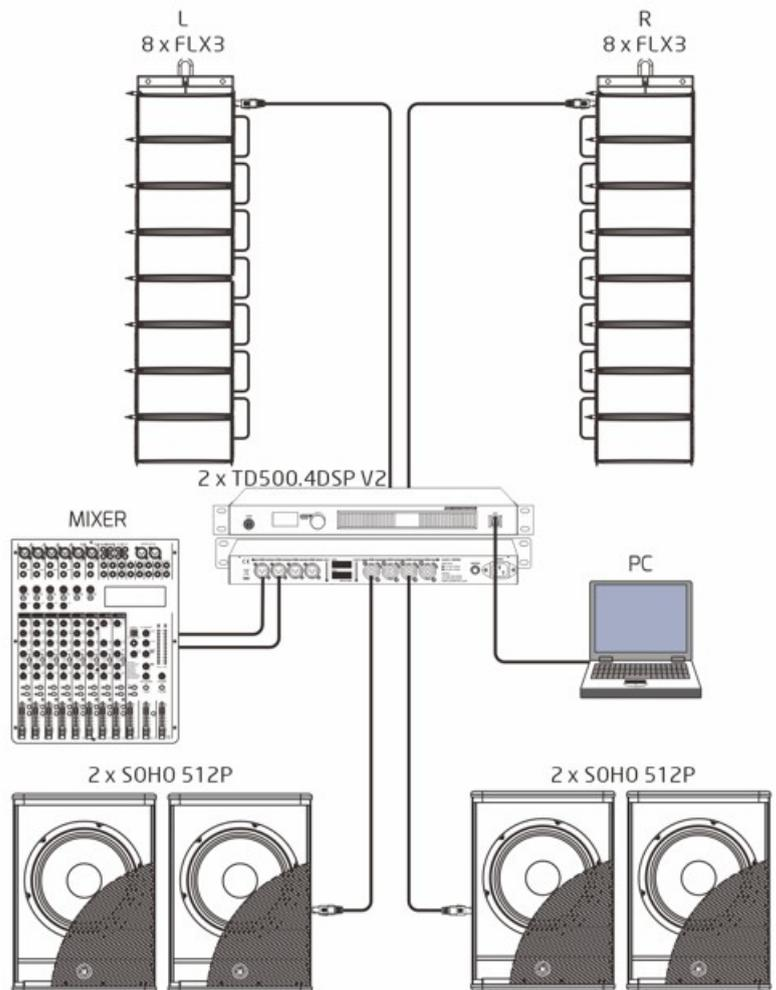

FLX3 Array System

**BEST
SELLER**



8 x FLX3
Passive Satellites
Dual 3" Woofers,
3 x 0.5" Tweeter

4000W **CE**
PEAK POWER APPROVED



8 x FLX3
Passive Satellites
Dual 3" Woofers,
3 x 0.5" Tweeter



TD500.4 DSP V2
Amplifier with DSP



2 x SOHO S12P
Subwoofer 12" Passive



MAXHEB
POWER MODULE Optimum Headroom & SPL



**Rigging
READY!**



2 x SOHO S12P
Subwoofer 12" Passive

X3 Technical Specifications

X3

System Type	4" Two-way passive system
Output Power	30W Continuous / 60W Program
Sensitivity (1W/1m)	88dB
Maximum SPL @ 1m	103dB Max. (calculated)
Frequency Response	100Hz-20KHz (-10dB)
Impedance	8 Ohm
Transducer Low	4" Neodymium Woofer, 1" Voice Coil
Transducer High	3 x 0.5" soft dome tweeter / 16Ω
Crossover Frequency	3.0KHz
Dispersion (-6dB)	110° Horizontal, 20° Vertical (one module)
Attachment Points	Adjustable Rigging System & Vertical Splay in 0° - 4° - 8° - 12° Increments from 0° - 12°
Connectors	Parallel or Series Ø6.3mm Socket / Selection Switch
Enclosure Construction	Aluminum alloy enclosure, Resistant Black Paint, Steel Grille with foam, Steel Stirrup Material, 3 Flying Points
Dimensions (HxWxD)	141 x 170 x 162 mm / 5.55" x 6.69" x 6.38"
Net Weight	1.46 Kg / 3.22 lbs

X3
Front View



SOHO S12P

System Type	12" Passive Subwoofer Speaker
Output Power	150W Continuous / 300W Program / 600W Peak
Sensitivity	122dB Continuous / 125dB Peak
Frequency Response	45Hz-2.8KHz (-10dB)
Impedance	4 Ohm
Transducer Low	12" Ferrite Woofer, 2.55" Voice Coil
Connectors	4 Pin Terminal Block and 2 x NL-4 Speakon Parallel Socket
Enclosure Construction	Plywood Cabinet, Resistant Black
Mounting	One metal standard Pole-mount
Dimensions (HxWxD)	500 x 350 x 542 mm / 19.69" x 13.78" x 21.34"
Net Weight	20.10 Kg / 44.31 lbs

X3
Rear View

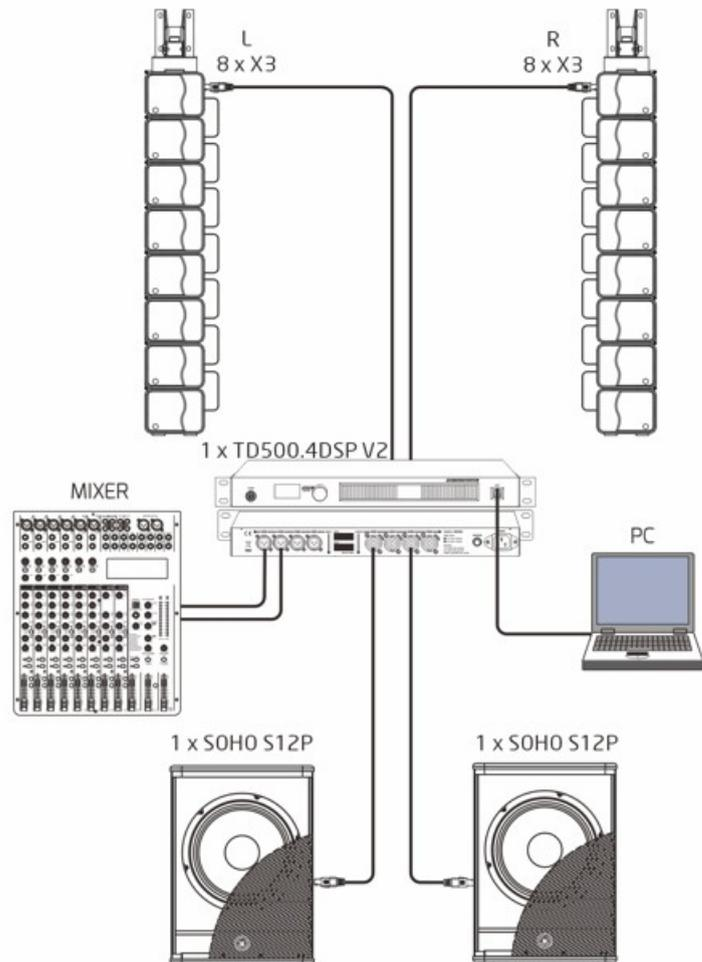
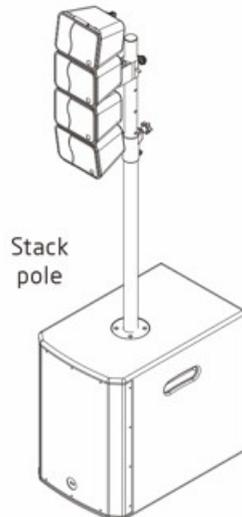
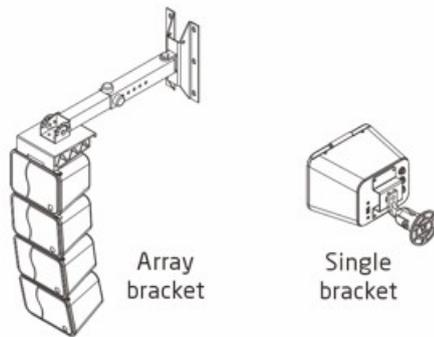

X3 Mini Array System

**BEST
SELLER**



8 x X3
Passive Satellites
4" Woofer,
3 x 0.5" Tweeter



8 x X3
Passive Satellites
4" Woofers,
3 x 0.5" Tweeter



TD500.4 DSP V2
Amplifier with DSP



MAXHEB
POWER MODULE Optimum Headroom & SPL



1 x SOHO S12P
Subwoofer 12" Passive



1 x SOHO S12P
Subwoofer 12" Passive

MegaSys 1 System Technical Specifications

MegaSys 1 System

Frequency Response	40Hz-20Hz (-10dB)
Total amplifier power	2000W continuous / 4000W program / 8000W peak Class D
Maximum SPL@1M	134dB
Crossover frequency	220Hz
Dispersion (-6dB)	120° horizontal
Dimensions (WxHxD)	430 x 2170 x 610 mm (16.93" x 85.43" x 24.02")
Weight	48 kg (105.8 lbs)

TP

System type	3.5" passive crossover speaker system
Output power	180W continuous, 360W program, 720W peak
Frequency Response (-6dB)	150Hz-20KHz
Impedance	16Ω
Transducer treble	5 x 1" neodymium driver, 1.0" (25.4mm) voice coil
Transducer MID	6 x 3.5" woofer, 1.0" (25.4mm) voice coil
Enclosure construction	Aluminium cabinet, metal grille, resistant paint
Connector	4 pin smart mounting and connection
Diminsions (WxHxD)	103 x 890 x 130mm (4.05" x 35.03" x 5.11")
Weight	7.2 kg (15.9 lbs)

BM

System type	3.5" passive full range speaker system
Output power	180W continuous, 360W program, 720W peak
Frequency Response (-6dB)	150Hz-20KHz
Impedance	16Ω
Transducer low	6 x 3.5" woofer, 1.0" (25.4mm) voice coil
Enclosure construction	Aluminium cabinet, metal grille, resistant paint
Connector	4 pin smart mounting and connection
Diminsions (WxHxD)	103 x 650 x 130mm (4.05" x 25.59" x 5.11")
Weight	5.9 kg (13.0 lbs)

SUB

System type	15" active subwoofer speaker cabinet
Total amplifier power	2000W continuous / 4000W program / 8000W peak Class D @8Ω
Amplifier, subwoofer	1000W continuous / 2000W program / 4000W peak Class D @8Ω
Amplifier, satellite	500W+500W continuous / 2000W program / 4000W peak Class D @8Ω
Frequency Response (-6dB)	40Hz-210Hz
Electronic protections	over heat protection / short circuit protection / digital compressor
Connections	input: 1 x combo-XLR & 1/4", output: 1 x XLR thru & mixout
External controls	master volume / SUB volume / power / signal / limiter / protect LED indicator / bluetooth pair and TWS connection switch and LED indicator
Enclosure construction	Plywood cabinet, resistant black paint, metal grille with foam, rubber feet, integrated side handles
Mounting	Smart mounting and connection
Power supply	110V-240V~50/60Hz
Diminsions (WxHxD)	430 x 630 x 610mm (16.93" x 24.80" x 24.02")
Weight	35 kg (73.85 lbs)



MegaSys 1

NEW
MODEL

3-Way

8000W 134dB **CE**
TOTAL SYSTEM - PEAK POWER APPROVED

Stream music wirelessly from
your smart device



MAXHEB
POWER MODULE Optimum Headroom & SPL



DSP Enhanced
Bass Response
Stereo Bluetooth APP control
High-Efficiency Class D Amplifier

Your Own
Sound Calibration!



EVENT2K Technical Specifications

EVENT 2K SYSTEM

Frequency Response	40Hz - 20KHz (-10dB)
Total Amplifier Power	1000W Continuous / 2000W Program / 4000W Peak Class-D
Maximum SPL@1M	128dB
Crossover Frequency	220Hz
Dispersion (-6dB)	120° Horizontal
Dimensions (WxHxD)	440 x 2015 x 640 mm / 17.32" x 79.33" x 25.20"
Net Weight	37.81 Kg / 83.35 lbs

Subwoofer

System Type	15" Active Subwoofer Speaker Cabinet
Frequency Response (-6dB)	40Hz - 210Hz
Total Amplifier Power	1000W Continuous / 2000W Program / 4000W Peak Class-D
Amplifier, Subwoofer	500W Continuous / 1000W Program / 2000W Peak Class-D
Amplifier, Satellite	500W Continuous / 1000W Program / 2000W Peak Class-D
DSP Presets Modes	LIVE / Music / FLAT / SPEECH / DJ
Electronic Protections	Overheat Protection / Short Circuit Protection / Digital Compressor
Cooling	Temperature-controlled fan
Connections	Input: 4 x Combo-XLR & 1/4", 1 x RCA In L&R, 1 x 3.5 Stereo Jack, Output: 1 x XLR Thru & Mixout
External Controls	Volume Control / Switch for Input sens / Swtich for mode selector / Power ON with Green LED / Limiter with Red LED / Ground Lift / OLED DSP Display and Control / IP Control / MP3 and BT (optional)
Power Supply	115V/230V ~50/60Hz Switch mode
Enclosure Construction	Plywood Cabinet, Resistant Black Paint, Metal Grille with Foam, Rubber Feet, Integrated side handles
Mounting	Smart Mounting and Connection
Dimensions (WxHxD)	440 x 521 x 640 mm / 17.32" x 20.49" x 25.20"
Net Weight	26.1 Kg / 57.54 lbs

Pole

Enclosure Construction	15" Active Aluminium Cabinet, Metal Grille, Resistant Paint
Connector	2 x Electronic Adapter - 1 x Input Connector for Sub & Another with Input Connector for Satellite
Dimensions (WxHxD)	1135 x 354 mm / 13.94" x 4.43"
Net Weight	1.36 Kg / 3.0 lbs

Satellite

System Type	6 x 3.5" Passive Speaker System
Output Power	180W Continuous, 360W Program, 720W Peak
Sensitivity (1W/1M)	96dB
Frequency Response (-6dB)	150Hz-20KHz
Impedance	16 Ohm
Transducer Low	3.5" Woofer, 1" Voice Coil
Rotation	180 Degree Mechanical Adjustment
Enclosure Construction	Aluminium Cabinet, Metal Grille, Resistant Paint
Connector	2 x Electronic Adapter - 1 x Input Connector for AX Pole & Another with Input Connector for AXV62TP
Dimensions (WxHxD)	113 x 610 mm / 4.43" x 24.0"
Net Weight	5.2 Kg / 11.46 lbs

SAT-TP

System Type	6 x 3.5" Passive 6 x 3.5" Passive Speaker System
Output Power	180W Continuous, 360W Program, 720W Peak
Sensitivity (1W/1M)	96dB
Frequency Response (-6dB)	150Hz-20KHz
Impedance	16 Ohm
Transducer Low	3.5" Woofer, 1" Voice Coil
Rotation	180 Degree Mechanical Adjustment
Enclosure Construction	Aluminium Cabinet, Metal Grille, Resistant Paint
Connector	2 Pin smart connection
Dimensions (WxHxD)	113 x 583 mm / 4.43" x 22.96"
Net Weight	5.15 Kg / 11.35 lbs

Subwoofer rear view



4 Ch Mixer
DSP
OLED Display

Optional MP3/BT

EVENT2K SYSTEM



4000W **CE**
4 OHM PEAK POWER - TOTAL SYSTEM APPROVED

12 x 3.5" HD Speakers

15" Active Subwoofer

12 x 3.5" HD Speakers

15" Active Subwoofer

Easy to Set Up and Transport!

180°
Dispersion

MAXHEB
POWER MODULE Optimum Headroom & SPL

Hi-Def
COMPONENTS



Download the FREE
App from App Store
to Control!



EVENT4K Technical Specifications

EVENT 4K SYSTEM

Frequency Response	35Hz - 20KHz (-10dB)
Total Amplifier Power	2000W Continuous / 4000W Program / 8000W Peak / Class-D
Maximum SPL@1M	134dB
Crossover Frequency	200Hz
Dispersion (-6dB)	130° Horizontal
Dimensions (WxHxD)	460 x 2010 x 676 mm / 18.11" x 79.13" x 26.6"
Net Weight	50.15 Kg / 110.56 lbs

Subwoofer

System Type	2 x 15" Active Subwoofer Speaker Cabinet
Frequency Response	35Hz - 180Hz (-6dB)
Total Amplifier Power	2000W Continuous / 4000W Program / 8000W Peak / Class-D
Amplifier, Subwoofer	1000W Continuous / 2000W Program / 4000W Peak / Class-D
Amplifier, Satellite	1000W Continuous / 2000W Program / 4000W Peak / Class-D
DSP Presets Modes	LIVE / Music / SPEECH / DJ
Electronic Protections	Overheat Protection / Short Circuit Protection / Digital Compressor
Cooling	Temperature-controlled fan
Connections	Input: 4 x Combo-XLR & 1/4", 1 x RCA In L & R, 1 x 3.5 Stereo Jack, Output: 1 x XLR Thru & Mixout
External Controls	Volume Control / Switch for Input sens. / Switch for mode selector / Power ON with Green LED / Limiter with Red LED / Ground Lift / OLED DSP Display and Control / IP Control / MP3 and BT module (optional)
Power Supply	115V/230V ~50/60Hz Switch mode
Enclosure Construction	Plywood Cabinet, Resistant Black Paint, Metal Grille with Foam, Wheels, Integrated side handles
Mounting	Smart Mounting and Connection
Dimensions (WxHxD)	460 x 830 x 676 mm / 18.11" x 32.67" x 26.6"
Net Weight	40.47 Kg / 89.22 lbs

Satellite

System Type	24 x 3" Passive Speaker System
Output Power	480W Continuous, 960W Program, 1920W Peak
Sensitivity (1W/1M)	99dB
Frequency Response	150Hz-20KHz (-6dB)
Impedance	4 ohms
Transducer Low	3" Neodymium Fullrange Speaker, 0.8" Voice Coil
Enclosure Construction	Aluminium Cabinet, Metal Grille, Resistant Paint
Connector	2 Pin smart connection
Dimensions (WxHxD)	167 x 1170 mm / 6.57" x 46.06"
Net Weight	9.7 Kg / 21.38 lbs

EVENT4K
rear & side view



Subwoofer rear view



4 Ch Mixer
DSP
OLED Display

Optional MP3/BT

EVENT4K SYSTEM

**BEST
SELLER**

8000W **CE**
4 OHM PEAK POWER - TOTAL SYSTEM APPROVED



24 x 3.5" HD Speakers

2 x 15" Active
Subwoofers



24 x 3.5" HD Speakers

2 x 15" Active
Subwoofers

Easy to Set Up and Transport!

130°
Dispersion

MAXHED
POWER MODULE Optimum Headroom & SPL

Hi-Def
COMPONENTS



Download the FREE
App from App Store
to Control!



VA42.12 Technical Specifications

VA12SA

System Type	12" Active Subwoofer Speaker Cabinet
Frequency Response	40Hz - 500 Hz (-6dB)
Total Amplifier Power	1000W Continuous / 2000W Program / 4000W Peak / Class-D
Amplifier, Subwoofer	500W Continuous / 1000W Program / 2000W Peak / Class-D
Amplifier, Satellite	500W Continuous / 1000W Program / 2000W Peak / Class-D
SUB WOOFER	12" Woofer, 2.5" Voice Coil
DSP Presets	Center / Open / User
Sensitivity (1W/1M)	96dB
Maximum SPL@1M	130dB Max (Calculated)
Electronic Protections	Thermal DC / Overload / Digital Compressor / Limiter
Cooling	Temperature controlled fan
Connections	Input: 2 Combo - XLR & 1/4", RCA In L & R, 1 XLR Thru & Mix out
External	Volume Control / Switch for Input sens / Swtich for mode selector / Power ON with Green LED / Limiter with Red LED / Ground Lift /
Controls	IP Control / MP3 including
Power Supply	115V/230V ~50/60Hz
Enclosure Construction	Plywood Cabinet, Resistant Black Paint, Metal Grille with Foam, Rubber Feet, handles
Mounting	Holder with Input Jacks for VA-WP
Dimensions (HxWxD)	450 x 430 x 480 mm / 17.72" x 16.93" x 18.9"
Net Weight	20.51 Kg / 45.22 lbs

VA42TP

System Type	3.5" Passive Speaker System
Output Power	240W Program, 480W Peak
Sensitivity (1W/1M)	95dB
Maximum SPL @ 1m	122dB Max.
Frequency Response	160Hz-20KHz (-6dB)
Impedance	8 ohms
Transducer Low	4 x 3.5" Woofer, 1" Voice Coil
Crossover Frequency	500Hz
Dispersion(-6dB)	100° Horizontal
Attachment Points	Adjustable Rigging System, Horizontal Splay Rotation in -90°- 0° - 90° Increments from 180°
Connectors	Parallel or Series 6.3mm Socket / Selection Switch
Enclosure Construction	Plywood Cabinet, Resistant Paint, Metal Grille with Foam
Mounting	1 x Holder, 1 x Input Connector for VA42BM or VA-WP
Dimensions (HxWxD)	422 x 107 x 98 mm / 16.61" x 4.21" x 3.86"
Net Weight	3.41 Kg / 7.52 lbs

VA42BM

System Type	3.5" Passive Speaker System
Output Power	240W Program, 480W Peak
Sensitivity (1W/1M)	95dB
Maximum SPL @ 1m	122dB Max.
Frequency Response	160Hz-20KHz (-6dB)
Impedance	8 ohms
Transducer Low	4 x 3.5" Woofer, 1" Voice Coil
Crossover Frequency	500Hz
Dispersion(-6dB)	100° Horizontal
Connectors	Parallel or Series 6.3mm Socket / Selection Switch
Enclosure Construction	Plywood Cabinet, Resistant Paint, Metal Grille with Foam
Mounting	2 x Holder, 1 x Input Connector for VA-WP, Another with input connector for VA42TP
Dimensions (HxWxD)	448 x 107 x 98 mm / 17.64" x 4.21" x 3.86"
Net Weight	3.48 Kg / 7.67 lbs

VA-WP

System Type	POLE
Enclosure	Plywood Cabinet, Resistant Paint
Construction	Metal Grille with Foam
Mounting	2 x Holder, 1 x Input connector for Sub, another with Input Connector for Satellite BM/TP
Dimensions (HxWxD)	700 x 107 x 98 mm / 27.56" x 4.21" x 3.86"
Net Weight	2.7 Kg / 5.95 lbs



VA42.12 SYSTEM

**BEST
SELLER**

4000W **CE**
4 OHM PEAK POWER - TOTAL SYSTEM APPROVED



8 x 3.5" HD Speakers

12" Active Subwoofer



100°
Dispersion



8 x 3.5" HD Speakers

12" Active Subwoofer

MAXHEB
POWER MODULE Optimum Headroom & SPL

Hi-Def
COMPONENTS



Download the FREE
App from App Store
to Control!



SOHO V8 PLUS & S15 Technical Specifications

SOHO V8 PLUS

System Type	3.5" Passive Speaker System
Output Power	240W Continuous, 480W Program, 960W Peak
Sensitivity (1W/1M)	97dB
Maximum SPL @ 1m	127dB Max.
Frequency Response (-6dB)	140Hz - 20KHz
Impedance	4 Ohm
Transducer Low	7 x 3.5" Woofer, 1" Voice Coil, 1 x 3.5" wideband speaker with 1 x 1.35" coaxial tweeter
Crossover Frequency	350Hz, 24dB/Oct. ACTIVE
Dispersion(-6dB)	100° Horizontal
Enclosure Construction	Body In extruded wood, black paint
Mounting	One metal pole-mount, two M8 hanging-points
Dimensions (HxWxD)	130 x 760 x 103 mm / 5.12" x 29.92" x 4.06"
Net Weight	6.98 Kg / 15.39 lbs

SOHO S15 SUB

Subwoofer	15" Woofer - 2.5" Voice Coil
Frequency response -6dB	40Hz-500Hz
Total amplifier power	1400W PROGRAM / 2800W PEAK Class-D
Amplifier, subwoofer	700W PROGRAM / 1400W PEAK Class-D
Amplifier, satellite/ mid-high unit	700W PROGRAM / 1400W PEAK Class-D
Axial sensitivity 1W@1m	96dB / 130dB Max.
Electronic Protections	Thermal DC / Overload / Digital Compressor / Limit
Cooling	Temperature-controlled fan
Connections	Input: 2 Combo - XLR 1/4", 1 RCA in L&R / Output: SPK Satellite / XLR Link
External Controls	Volume Control / Switch for Input sens / Swtich for mode selector / Power ON with Green LED / Limiter with Red LED / Ground Lift / IP Control
Power Supply	110-120V~50/60Hz, 220-240V~50/60Hz Switchable
Enclosure Construction	Plywood cabinet, resistant black paint, metal grille with foam, rubber feet, handles
Mounting	One metal standard 35mm pole-mount
Dimensions (HxWxD)	520 x 480 x 562 mm / 20.47" x 18.9" x 22.13"
Net Weight	28.3 Kg / 62.39 lbs

Also available with in 12" subwoofer, SOHO S12



SOHO S15 rear view



SOHO V8 PLUS & S15 SYSTEM

1 x 3.5" Coaxial Speaker

1 x 3.5" Coaxial Speaker

2800W **CE**
4 OHM PEAK POWER - TOTAL SYSTEM APPROVED

7 x 3.5" HD Speakers

7 x 3.5" HD Speakers

S15 Active Subwoofer

S15 Active Subwoofer

100° Dispersion

Easy to Set Up and Transport!

MAXHEB
POWER MODULE Optimum Headroom & SPL

Hi-Def
COMPONENTS

coaxial
design



Download the FREE App from App Store to Control!



KS HD Series Technical Specifications

	KS HD8A	KS HD10A
System Configuration	2-way Active Loudspeaker with DSP/OLED	
LF Transducer	8" Woofer, 2.5" Voice coil	10" Woofer, 2.5" Voice coil
HF Transducer	1" exit, ferrite compression driver with 1.75" edgewound copper clad aluminium voice coil	
Power Rating	1000W Continuous / 2000W Program / 4000W Peak Class D	
Frequency Response(-6 dB)	60Hz-20KHz	50Hz-20KHz
Frequency Range (-10 dB)	55Hz-20KHz	45Hz-20KHz
Maximum Rated SPL	127dB Peak	129dB Peak
Crossover Frequency	At 1.8KHz with 24dB filter slope, Linkwitz-Riley Type	
Horn Coverage	110° horizontal x 60° Vertical (Nominal)	
Controls	Power / 3 x Level / Rotary encoder	
Indicators	Monochrome OLED Display 1.65" x 1.1" (42.04mm x 27.22mm), 2 x Power LED (front and rear), 3 x Input Signal LED, Input 1 MIC selected LED, Input 2 HI-Z selected LED, Limiter active LED	
Connectors	2 x locking XLR/F 1/4" combo (Mic/Line Input and Hi-Z/Line Input), 1 x 3.5mm TRS (Stereo Input), 1 x XLR/M (Mix Output), 1 x locking IEC power connector	
AC Power Input	110V-240V~50/60Hz	
Enclosure	Plywood cabinet, resistant black paint, rubber feet, metal handle, metal grille with black foam	
Attachment Points	One metal standard pole-mount, 10 x M10 threaded inserts plus integrated Pull-Back	
Dimensions (HxWxD)	460 x 272.2 x 302 mm / 18.11" x 10.74" x 11.88"	520 x 299 x 310 mm / 20.5" x 11.77" x 12.2"
Net Weight	13.2 Kg / 29.1 lbs	15.1 Kg / 33.3 lbs

	KS HD12A	KS HD15A
System Configuration	2-way Active Loudspeaker with DSP/OLED	
LF Transducer	12" Woofer, 3" Voice coil	15" Woofer, 3" Voice coil
HF Transducer	1" exit, ferrite compression driver with 1.75" edgewound copper clad aluminium voice coil	
Power Rating	1000W Continuous / 2000W Program / 4000W Peak Class D	
Frequency Response(-6 dB)	48Hz-20KHz	45Hz-20KHz
Frequency Range (-10 dB)	42Hz-20KHz	40Hz-20KHz
Maximum Rated SPL	131dB Peak	133dB Peak
Crossover Frequency	At 1.6KHz with 24dB filter slope, Linkwitz-Riley Type	At 1.5KHz with 24dB filter slope, Linkwitz-Riley Type
Horn Coverage	110° horizontal x 60° Vertical (Nominal)	
Controls	Power / 3 x Level / Rotary encoder	
Indicators	Monochrome OLED Display 1.65" x 1.1" (42.04mm x 27.22mm), 2 x Power LED (front and rear), 3 x Input Signal LED, Input 1 MIC selected LED, Input 2 HI-Z selected LED, Limiter active LED	
Connectors	2 x locking XLR/F 1/4" combo (Mic/Line Input and Hi-Z/Line Input), 1 x 3.5mm TRS (Stereo Input), 1 x XLR/M (Mix Output), 1 x locking IEC power connector	
AC Power Input	110V-240V~50/60Hz	
Enclosure	Plywood cabinet, resistant black paint, rubber feet, metal handle, metal grille with black foam	
Attachment Points	One metal standard pole-mount, 10 x M10 threaded inserts plus integrated Pull-Back	
Dimensions (HxWxD)	637 x 363 x 350 mm / 25.07" x 14.28" x 13.78"	726 x 421 x 410 mm / 28.58" x 16.57" x 16.14"
Net Weight	19.2 Kg / 42.3 lbs	25.1 Kg / 55.3 lbs



FOH or
Monitor!

Scratch-Resistant Paint



HD Speaker with DSP/OLED

KS HD Series

NEW
MODEL

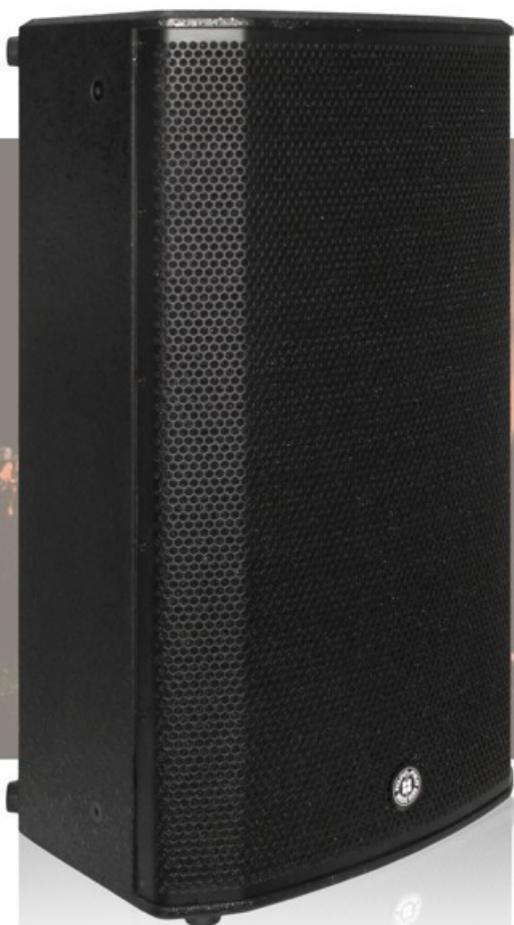

2000W 130dB **CE**
TOTAL SYSTEM - PROGRAM POWER APPROVED

1.75" Driver

3-Input Mixer with DSP



Bi-Amp

Mix Out



MAXHEB
POWER MODULE Optimum Headroom & SPL



KS HD8A

2.5"
VOICE COIL



KS HD10A

2.5"
VOICE COIL

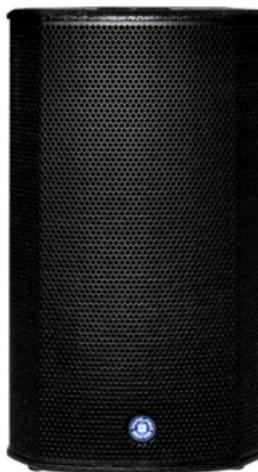

KS HD12A

3"
VOICE COIL

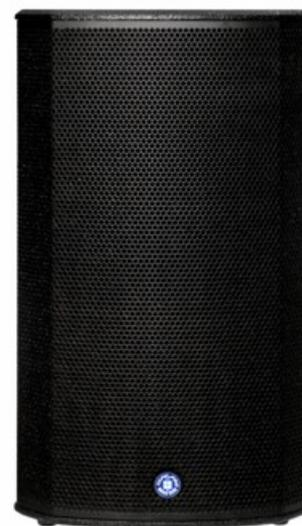

KS HD15A

3"
VOICE COIL

KS HD Subwoofers Technical Specifications

KS HD15A SUB

System Type	15" Active Vented Subwoofer
Power Rating	1000W Continuous / 2000W Program / 4000W Peak
Transducer Low	15" Ferrite Woofer, 3" Voice Coil with Long Excursion
Frequency Response (-6dB)	45Hz - 120Hz
Max.SPL	129dB
DSP Presets Modes	BOOST / EXTENDED LF / NORMAL
Crossover Frequency	80Hz / 100Hz / 120Hz selectable
Electronic Protections	Overheat Protection / Short Circuit Protection / Digital Compressor
Cooling	Temperature-controlled fan
Connectors	Input: Left Mono (Combo) / Right (XLR-F), Output: Left Mono / Right (XLR-M)
External Controls	Volume Control / Phase Switch / Switch for EQ Mode Selector / Switch for LPF / Power ON with Green LED / Limiter with Red LED
Power Supply	100-240V ~50/60Hz
Enclosure Construction	Plywood Cabinet, Resistant Black Paint, Metal Grille with Foam, Rubber Feet, Double handles
Mounting	One Metal Standard Pole-Mount
Dimensions (WxHxD)	580 x 450 x 503 mm / 22.83" x 17.72" x 19.80"
Net Weight	25.2 Kg / 55.55 lbs

KS HD18A SUB

System Type	18" Active Vented Subwoofer
Power Rating	1000W Continuous / 2000W Program / 4000W Peak
Transducer Low	18" Ferrite Woofer, 3" Voice Coil with Long Excursion
Frequency Response (-6dB)	40Hz - 120Hz
Max.SPL	130dB
DSP Presets Modes	BOOST / EXTENDED LF / NORMAL
Crossover Frequency	80Hz / 100Hz / 120Hz selectable
Electronic Protections	Overheat Protection / Short Circuit Protection / Digital Compressor
Cooling	Temperature-controlled fan
Connectors	Input: Left Mono (Combo) / Right (XLR-F), Output: Left Mono / Right (XLR-M)
External Controls	Volume Control / Phase Switch / Switch for EQ Mode Selector / Switch for LPF / Power ON with Green LED / Limiter with Red LED
Power Supply	100-240V ~50/60Hz
Enclosure Construction	Plywood Cabinet, Resistant Black Paint, Metal Grille with Foam, Rubber Feet, Double handles
Mounting	One Metal Standard Pole-Mount
Dimensions (WxHxD)	661 x 535 x 537 mm / 26.02" x 21.06" x 21.12"
Net Weight	31.0 Kg / 68.33 lbs

KS HD Subwoofers

NEW
MODEL

4000W 130dB **CE**
TOTAL SYSTEM - PROGRAM POWER APPROVED



XLR-F I/O Crossover Frequency
3 Low Pass Filter Modes
& Phase Switch

Scratch-Resistant Paint Process



KS HD15A SUB

3"
VOICE COIL



KS HD18A SUB

3"
VOICE COIL

KS CS Series Technical Specifications

	KS CS8A	KS CS10A	KS CS12A
System Type	2- Way Active Vented Speaker with DSP		
Transducer Low	8" Woofer, 2" voice coil	10" Woofer, 2.5" voice coil	12" Woofer, 3" voice coil
Transducer Driver	1" Celestion compression driver, 1.75" voice coil		
Frequency Response (-6dB)	60Hz - 20KHz	55Hz - 20KHz	50Hz - 20KHz
Crossover Frequency (Linkwitz-Riley Type)	At 1.8KHz with 24dB filter slope	At 1.8KHz with 24dB filter slope	At 1.6KHz with 24dB filter slope
Max SPL	124dB Max	126dB Max	128dB Max
Power Rating	800W Continuous / 1600W Program / 3200W Peak		1000W Continuous / 2000W Program / 4000W Peak
Input Connector	Line / Mic (COMBO) / Link - XLR		
DSP Presets	Flat / Loudness / User (Custom Sound)		
Line Input	Combo connector -6dBu		
External Controls	Volume Control / Power ON with Green LED / Clip Limiter with Red LED / Ground Lift / Switch for input sens. / Switch On for front LED / USB		
Electronic Protections	Thermal / Convection-Fan / Overload / Digital Limiter / Compressor		
Power Supply	110V-120V~50/60Hz, 220-240V~50/60Hz Switchable		
Enclosure Construction	Plywood cabinet, resistant black paint, metal grille with black foam, rubber foot, plastic handles		
Mounting	One metal standard pole-mount 10 x M10 Flying points	One metal standard pole-mount 12 x M10 Flying points	One metal standard pole-mount 12 x M10 Flying points
Dimensions (HxWxD)	460 x 277 x 300 mm 18.11" x 10.91" x 11.81"	583 x 332 x 325 mm 22.95" x 13.07" x 12.8"	625 x 430 x 350 mm 24.61" x 16.93" x 13.78"
Net Weight	15.93 Kg / 35.12 lbs	19.72 Kg / 43.78 lbs	23.18 Kg / 51.1 lbs
Volume	2.55 CFT	3.89 CFT	4.9 CFT

	KS CS15A	KS CS215A
System Type	2- Way Active Vented Speaker with DSP	
Transducer Low	15" Woofer, 3" voice coil	2 x 15" Woofer, 3" voice coil
Transducer Driver	1" Celestion compression driver, 1.75" voice coil	
Frequency Response (-6dB)	48Hz - 20KHz	45Hz - 20KHz
Crossover Frequency (Linkwitz-Riley Type)	At 1.5KHz with 24dB filter slope	At 1.5KHz with 24dB filter slope
Max SPL	130dB Max	133dB Max
Power Rating	1000W Continuous / 2000W Program / 4000W Peak	
Input Connector	Line / Mic (COMBO) / Link - XLR	
DSP Presets	Flat / Loudness / User (Custom Sound)	
Line Input	Combo connector -6dBu	
External Controls	Volume Control / Power ON with Green LED / Clip Limiter with Red LED / Ground Lift / Switch for input sens. / Switch On for front LED / USB	
Electronic Protections	Thermal / Convection-Fan / Overload / Digital Limiter / Compressor	
Power Supply	110V-120V~50/60Hz, 220-240V~50/60Hz Switchable	
Enclosure Construction	Plywood cabinet, resistant black paint, metal grille with black foam, rubber foot, plastic handles	
Mounting	One metal standard pole-mount 12 x M10 Flying points	12 x M10 Flying points
Dimensions (HxWxD)	700 x 430 x 386 mm 27.56" x 16.93" x 15.2"	1100 x 430 x 386 mm 43.314" x 16.93" x 15.2"
Net Weight	23.16 Kg / 51.06 lbs	39.12 Kg / 86.25 lbs
Volume	6.82 CFT	10.22 CFT

Active Speaker with DSP



KS CS Series



2000W **134dB** **CE**
TOTAL SYSTEM - PROGRAM POWER APPROVED

1.75" HD Driver

DSP
Enhanced
Bass Response



Download the FREE App from App Store to Control!

Your Own Sound Calibration!



KS CS8A

2"
VOICE COIL



KS CS10A

2.5"
VOICE COIL



KS CS12A

3"
VOICE COIL



KS CS15A

3"
VOICE COIL



KS CS215A

3"
VOICE COIL

KS Active Subwoofers Technical Specifications

	KS 15A SUB	KS 18A SUB
System Type	Active subwoofer	Active subwoofer
Power Rating	1000W Continuous / 2000W Program / 4000W Peak	1000W Continuous / 2000W Program / 4000W Peak
Transducer Low	15" Woofer, 3" Sandwich Voice Coil with long excursion	18" Woofer, 3" Sandwich Voice Coil with long excursion
Max SPL	128dB Max.	129dB Max.
Active Crossover	BandPass type 12dB/oct.	BandPass type 12dB/oct.
Frequency Response (-6dB) Under analog processor	45Hz - 120Hz	40Hz - 120Hz
Input Connector	In-Left / Mono (COMBO) Right (XLR-F) / Out-Left / Mono Right (XLR-M) / Link-Left / Mono-Right (XLR-M) Balanced (15K Ohm)	
External Controls	Volume Control / Phase Switch / HPF-80Hz for L-R Satellite or By Pass / Power ON with Green LED / Clip Limiter with Red LED / Ground Lift	
Electronic Protections	Thermal / Convection-Fan / Overload / Lim. / Compressor	
Power Supply	110-120V~50/60Hz or 220-240V~50/60Hz Switch mode	
Enclosure Construction	Plywood cabinet, metal grille, rubber feet	
Mounting	One metal standard pole-mount	
Dimensions (HxWxD)	450 x 580 x 485 mm (17.72" x 22.84" x 19.1")	535 x 661 x 516 mm (21.06" x 26.02" x 20.32")
Net Weight	24.95 Kg / 55.01 lbs	31.94 Kg / 70.42 lbs
Volume	7.58 CFT	10.45 CFT

	KS218A SUB
System Type	Active subwoofer
Power Rating	2000W Continuous / 4000W Program / 8000W Peak
Transducer Low	2 x 18" Woofer, 3" Sandwich Voice Coil with long excursion
Max SPL	133dB Max.
Active Crossover	BandPass type 12dB/oct.
Frequency Response (-6dB) Under analog processor	35Hz - 120Hz
Input Connector	In-Left / Mono (COMBO) Right (XLR-F) / Out-Left / Mono Right (XLR-M) / Link-Left / Mono-Right (XLR-M) Balanced (15K Ohm)
External Controls	Volume Control / Phase Switch / HPF-80Hz for L-R Satellite or By Pass / Power ON with Green LED / Clip Limiter with Red LED / Ground Lift
Electronic Protections	Thermal / Convection-Fan / Overload / Lim. / Compressor
Power Supply	110-120V~50/60Hz or 220-240V~50/60Hz Switch mode
Enclosure Construction	Plywood cabinet, metal grille, rubber feet
Mounting	One metal standard pole-mount
Dimensions (HxWxD)	353 x 519 x 1000 mm / 13.9" x 20.43" x 39.37"
Net Weight	46.64 Kg / 102.82 lbs
Volume	15.89 CFT

KS Active Subwoofers

**BEST
SELLER**

4000W 138dB **CE**
TOTAL SYSTEM - PROGRAM POWER APPROVED



XLR-F Link

Ground & Phase Switch

MAXHEB
POWER MODULE *Optimum Headroom & SPL*

Hi-Def
COMPONENTS



KS 15A SUB

3"
VOICE COIL



KS 18A SUB

3"
VOICE COIL



KS 218A SUB

3"
VOICE COIL

KS Series Technical Specifications

	KS 8	KS 10	KS 12	KS 15	KS 215
System Type	8" Woofer, 2" voice coil	10" Woofer, 2.5" voice coil	2-Way Bass Reflex Speaker	15" Woofer, 3" voice coil	2 x 15" Woofer, 3" voice coil
Transducer Low	12" Woofer, 3" voice coil				
Transducer Driver	1" Compression Driver, 1.75" Voice Coil				
Frequency Response	65Hz - 20KHz (-6dB)	60Hz - 20KHz (-6dB)	55Hz - 20KHz (-6dB)	48Hz - 20KHz (-6dB)	45Hz - 20KHz (-6dB)
Crossover Frequency	1.8K Hz	3KHz	2KHz	2KHz	2KHz
Nominal Impedance	8 Ohms				4 Ohms
Max SPL	123dB Max.	125dB Max.	130dB Max.	132dB Max.	134dB Max.
Power Rating	200W / RMS 400W / PROGRAM	300W / RMS 600W / PROGRAM	400W / RMS 800W / PROGRAM	500W / RMS 1000W / PROGRAM	1000W / RMS 2000W / PROGRAM
Input Connector	2 x SPK4 style				
Electronic Protection	High Frequency Protection				
Enclosure Construction	Plywood cabinet, resistant black paint, metal grille, rubber feet, two plastic handles				
Mounting	Metal pole-mount, 10 x M10 Flying Points	Metal pole-mount, 12 x M10 Flying Points	Metal pole-mount, 12 x M10 Flying Points	Metal pole-mount, 12 x M10 Flying Points	Metal pole-mount, 12 x M10 Flying Points
Dimensions (HxWxD)	460 x 276.4 x 300mm 18.11" x 10.89" x 11.81"	583 x 333.2 x 325mm 22.95" x 13.12" x 12.8"	625 x 381 x 350mm 24.6" x 15" x 13.8"	700 x 431 x 386.7mm 27.6" x 16.9" x 15.2"	1100 x 431 x 386.7mm 43.4" x 16.9" x 15.2"
Net Weight	13.2 kg	16.8 kg	22.5 kg	25.63 kg	38.89 kg
Volume	2.554CFT	3.893 CFT	4.95 CFT	6.82 CFT	10.22 CFT

	KS15SUB	KS18SUB
System Type	Bass Reflex Subwoofer	
Transducer Low	15" Woofer, 3" voice coil	18" Woofer, 3" voice coil
Frequency Response	45Hz - 200Hz (-6dB)	40Hz - 200Hz (-6dB)
Crossover Frequency	500Hz	500Hz
Nominal Impedance	8 Ohms	8 Ohms
Max SPL	133dB Max.	134dB Max.
Power Rating	500W / RMS - 1000W / PROGRAM	500W / RMS - 1000W / PROGRAM
Input Connector	2 x NL4 (Pin 1+, Pin 1-)	
Enclosure Construction	Plywood cabinet, resistant black paint, metal grille, rubber feet, two handles	
Mounting	Metal pole-mount	
Dimensions (HxWxD)	450 x 580 x 485mm 17.72" x 22.84 x 19.1"	535 x 661 x 515.5mm 21.06" x 26.02" x 20.3"
Net Weight	22.5 kg	28.4 kg
Volume	7.58 CFT	10.45 CFT

KS Series

**BEST
SELLER**

2000W 136dB **CE**
TOTAL SYSTEM - PROGRAM POWER APPROVED



KS8

2"
VOICE COIL

KS10

2.5"
VOICE COIL

KS12

3"
VOICE COIL

KS15

3"
VOICE COIL

KS215

3"
VOICE COIL



KS15SUB

3"
VOICE COIL

KS18SUB

3"
VOICE COIL

ZP Series Active Speaker Technical Specifications

	ZP-10A	ZP-12A	ZP-15A
System Type	2-Way Active Vented Loudspeaker System		
Power System	Bi-Amp DSP Processor, 1000W continuous RMS (Class-D LF-650W+HF-350W), 4000W peak (2600W LF+1400W HF)		
Transducer Low	10" (246mm), 2.5" (65mm) voice coil	12" (296mm), 3" (76mm) voice coil	15" (367mm), 3" (76mm) voice coil
Transducer High	1" Throat Compression Driver, 1.4" (35mm) voice coil		
Crossover Frequency	3.0KHz	2.0KHz	2.0KHz
Max SPL (@1m)	129dB (peak), 126dB (continuous)	131dB (peak), 128dB (continuous)	134dB (peak), 131dB (continuous)
Frequency Response	54Hz-20KHz (-3dB)	53Hz-20KHz (-3dB)	50Hz-20KHz (-3dB)
Frequency Range	48Hz-20KHz (-10dB)	46Hz-20KHz (-10dB)	43Hz-20KHz (-10dB)
Horn Coverage	90°Horizontal x 60°Vertical (nominal)		
DSP Preset Modes	Live-Music-Speech-Monitor		
Connectors	2 x XLR+1/4" (6.35mm) TRS combo inputs (line / mic); 1 x 3.5 stereo AUX in, 1 x XLR mix output (link); 1 x IEC power cable input		
Bluetooth Stereo	Stereo L/R-Vol-pair-link switch (APP control)		
Controls	Volume Control knob, AC Power Switch, Line/Mic toggle switch, DSP preset switch. BT pair and link switch		
Indicators	Signal/Clip Limiter LED, Four DSP Mode LEDs, BT Pair-Link LED, Power Switch LED		
Power	Connection: IEC Voltage: 110V-120V~, 220V-240V~, 50/60Hz, switchable Fuse: 100V-120V T10AL AC250V, or 220V-240V T5AL AC250V Consumption: 800W		
Electronic Protections	Electronic clip, thermal and transducer overdrive protection		
Enclosure	Trapezoidal, injection-molded, polypropylene with perforated steel grille 2 x handles (left and right sides)	Trapezoidal, injection-molded, polypropylene with perforated steel grille 3 x handles (top and both sides)	
Mounting / Installation	36mm standard pole-mount, suspended with integral M10 points, wedge monitor		
Dimensions (HxWxD)	528 x 332 x 315 mm (20.8" x 13.1" x 12.4")	615 x 364 x 348 mm (24.2" x 14.3" x 13.7")	680 x 421 x 382 mm (26.8" x 16.6" x 15.0")
Weight	12.3 Kg / 27.1 lbs	16.3 Kg / 35.9 lbs	18.8 Kg / 41.3 lbs

ZP-10A



ZP-12A



ZP-15A



Active Plastic Cabinet Speakers with DSP/BT

ZP Series

NEW
MODEL



4000W 134dB **CE**
TOTAL SYSTEM - PEAK POWER APPROVED

Stream music wirelessly from
your smart device



MAXHEB
POWER MODULE Optimum Headroom & SPL



Rigging
READY!

DSP Enhanced
Bass Response
Stereo Bluetooth APP control
High-Efficiency Class D Amplifier

Your Own
Sound Calibration!



ZP-10A



ZP-12A



ZP-15A

FORZA PLUS Series Technical Specifications

FORZA 12A PLUS

System Type	2-Way Active Plastic Loudspeaker
Power System	Class D SMPS (Bi-AMP, LF 350W / RMS+HF 35W/RMS), 1660W Peak
Continuous Power	415W (Low:350W / High: 65W)
Program Power	830W
Drivers	Low-Frequency: 12.0" (318mm) driver, 3.0" (75mm) voice coil, 400W/4Ω, Ferrite High-Frequency: 1.0" (25mm) titanium-diaphragm compression driver, 1.35" (35mm) voice coil, 8Ω/20W
Crossover Frequency	2.6KHz
Max SPL	126dB (Peak), 94dB (Continuous) (dB-SPL@1m)
Frequency Response	65Hz-20KHz (-3dB)
Frequency Range	57Hz-20KHz (-10dB)
Horn Coverage	90° horizontal x 60° Vertical (Nominal)
Connectors	Input1-Mic with XLR x 1 & 6.3jack / Input2-Line with XLR x 1 & 6.3jack x 1 & 3.5jack x 1 / XLR Mix Output
USB Player	With USB / MP3 Player, Bluetooth (BT 5.3)
Controls	Input 1 & 2 and Master Volume Control / 2 Band EQ-High & Low
Indicators	Power ON with Green LED / Clip Limiter with Red LED
Power	Connection: IEC / Voltage: 110-120V~, 220-240V~, 50/60Hz, switchable / Fuse: 100-120V T6.3AL AC250V, or 220-240V T3.15AL AC250V / Consumption:420W
Protection	Thermal / Overload / Analog Limiter / Compressor
Enclosure	Injection-Molded Polypropylene, Multi-Angle for Main or Monitor Applications, Metal Grille, Rubber Feet, 3xHandles (Both Side and Top)
Mounting / Installation	36mm Standard Pole-Mount / M10x4pcs Flying Points (Optional), Wedge Monitor
Dimensions (HxWxD)	605 x 380 x 340 mm / 23.82" x 14.96" x 13.39"
Net Weight	18.2 Kg / 40.12 lbs

FORZA 15A PLUS

System Type	2-Way Active Plastic Loudspeaker
Power System	Class D SMPS (Bi-AMP, LF 350W / RMS+HF 35W/RMS), 1660W Peak
Continuous Power	415W (Low:350W / High: 65W)
Program Power	830W
Drivers	Low-Frequency: 15.0" (382mm) driver, 3.0" (75mm) voice coil, 400W/4Ω, Ferrite High-Frequency: 1.0" (25mm) titanium-diaphragm compression driver, 1.35" (35mm) voice coil, 8Ω/20W
Crossover Frequency	2.5KHz
Max SPL	128dB (Peak), 96dB (Continuous) (dB-SPL@1m)
Frequency Response	60Hz-20KHz (-3dB)
Frequency Range	55Hz-20KHz (-10dB)
Horn Coverage	90° horizontal x 60° Vertical (Nominal)
Connectors	Input1-Mic with XLR x 1 & 6.3jack / Input2-Line with XLR x 1 & 6.3jack x 1 & 3.5jack x 1 / XLR Mix Output
USB Player	With USB / MP3 Player, Bluetooth (BT 5.3)
Controls	Input 1 & 2 and Master Volume Control / 2 Band EQ-High & Low
Indicators	Power ON with Green LED / Clip Limiter with Red LED
Power	Connection: IEC / Voltage: 110-120V~, 220-240V~, 50/60Hz, switchable / Fuse: 100-120V T6.3AL AC250V, or 220-240V T3.15AL AC250V / Consumption:420W
Protection	Thermal / Overload / Analog Limiter / Compressor
Enclosure	Injection-Molded Polypropylene, Multi-Angle for Main or Monitor Applications, Metal Grille, Rubber Feet, 3xHandles (Both Side and Top)
Mounting / Installation	36mm Standard Pole-Mount / M10x4pcs Flying Points (Optional), Wedge Monitor
Dimensions (HxWxD)	625 x 386 x 370 mm / 24.61" x 15.20" x 14.57"
Net Weight	19.2 Kg / 42.33 lbs

Active Plastic Speakers



FORZA PLUS Series



1660W **128dB** **CE**
TOTAL SYSTEM - PEAK POWER APPROVED

3 Channel* Mixer
(Mic / XLR / Line / Music Player)



2-band EQ / Master Volume / Mix Out

Ti TITANIUM DRIVER

MAXHEB
POWER MODULE Optimum Headroom & SPL

Hi-Def
COMPONENTS



FORZA 12A PLUS

3"
VOICE COIL



FORZA 15A PLUS

3"
VOICE COIL

Avanti 15A Technical Specifications

System Type	2-Way Active Vented Speaker
Transducer Low	15" Woofer, 2" voice coil
Transducer Driver	1" NEO Driver, 1" Voice Coil
Horn Coverage H° x V°	90°H x 45°V
Frequency Response (-6dB)	55Hz - 20KHz
Crossover Frequency	2.5KHz
Max SPL	117dB Max.
Power Rating	240W (PROGRAM) / 500W (PEAK)
USB Player	With USB & Micro SD CARD / BT
Connector	INPUT 1 - Mic with XLR x 1 & 6.3 Jack x 1 / INPUT 2 - Line with XLR x 1 & 6.3 jack x 1 & 3.5 jack x 1
External Controls	Input 1 & 2 and Master Volume Control / 2 Band EQ - High & Low / Power ON with Green LED / Clip Limiter with Red LED
Electronic Protections	Thermal / Overload / Analog limiter / Compressor
Power Supply	110V / 240V Switch mode
Enclosure Construction	Plastic cabinet, Trapezoidal & Monitor shape, Metal grille, Rubber feet, 3 x Handles (both side and Top)
Mounting	36mm standard pole-mount / M10 x 4pcs Flying Points (Optional)
Dimensions (HxWxD)	632 x 386 x 366 mm / 24.88" x 15.2" x 14.41"
Net Weight	14.09 Kg / 31.06 lbs
Volume	5.47CFT



Avanti 15A
Rear View

HD Active Speaker

Avanti 15A

**BEST
SELLER**



500W **118dB** **CE**
TOTAL SYSTEM - PEAK POWER APPROVED

3 Channel* Mixer
(Mic / XLR / Line / Music Player)



2-band EQ / Master Volume / Mix Out

MAXHEB
POWER MODULE *Optimum Headroom & SPL*

Hi-Def
COMPONENTS

**NEODYMIUM
ND
DRIVER**



Built-in Media Player



AVANTI 15A

2"
VOICE
COIL

X CS Series Technical Specifications

	X CS12A
System Type	2-Way Active Vented Speaker / Bi-Amp. With DSP processor
Transducer Low	12" Woofer, 2" voice coil
Transducer Driver	1" Neodymium Driver, 1" Voice Coil
Horn Coverage H° x V°	90°H x 60°V
Frequency Response	50Hz-20KHz (-6dB)
Crossover Frequency	1.6KHz - DSP Processor
Max SPL	125dB Max.
AMP Power Output	400W Continuous (LF-Class D 350W,HF-Class AB 65W), 1600W Peak
Connector	Line/Mic With Combo & Link With XLR
External Controls	Volume Control / Lin & Mic Switch / Preset Switch / Power on with Green LED / Clip Limiter with Red LED / Ground Lift
Digital Presets	FLAT - MUSIC - USER
Electronic Protections	Thermal / Overload / Digital Limiter / Compressor
Power Supply	110V-120V~50/60Hz or 220V-240V~50/60Hz Switch mode
Enclosure Construction	Plastic cabinet,Trapezoidal & Monitor Shape, Metal Grille, Rubber Feet, 3 x Handles (Top and sides)
Mounting	36mm standard pole-mount
Dimensions (HxWxD)	458 x 411 x 683 mm / 18.03" x 16.18" x 26.89"
Net Weight	14.6 Kg / 32.19 lbs
Volume	4.54 CFT

	X CS15A
System Type	2-Way Active Vented Speaker / Bi-Amp. With DSP processor
Transducer Low	15" Woofer, 2" voice coil
Transducer Driver	1" Neodymium Driver, 1" Voice Coil
Horn Coverage H° x V°	90°H x 60°V
Frequency Response	45Hz-20KHz (-6dB)
Crossover Frequency	1.6KHz - DSP Processor
Max SPL	126dB Max.
AMP Power Output	400W Continuous (LF-Class D 350W,HF-Class AB 65W), 1600W Peak
Connector	Line/Mic With Combo & Link With XLR
External Controls	Volume Control / Lin & Mic Switch / Preset Switch / Power on with Green LED / Clip Limiter with Red LED / Ground Lift
Digital Presets	FLAT - MUSIC - USER
Electronic Protections	Thermal / Overload / Digital Limiter / Compressor
Power Supply	110V-120V~50/60Hz or 220V-240V~50/60Hz Switch mode
Enclosure Construction	Plastic cabinet,Trapezoidal & Monitor Shape, Metal Grille, Rubber Feet, 3 x Handles (Top and sides)
Mounting	36mm standard pole-mount
Dimensions (HxWxD)	468 x 488 x 708 mm / 18.43" x 19.21" x 27.87"
Net Weight	14.7 Kg / 32.41lbs
Volume	5.47 CFT

HD Active Speaker with DSP



X CS Series



1600W **126dB** **CE**
TOTAL SYSTEM - PEAK POWER APPROVED

1" Neodymium Driver



Download the free App from App Store to control!

DSP Enhanced Bass Response

Your Own Sound Calibration!



X CS12A

X CS15A

2"

VOICE COIL

2"

VOICE COIL

STARK DSP Series Active Speaker Technical Specifications

	STARK 8A DSP	STARK 10A DSP	STARK 12A DSP	STARK 15A DSP
System Type	2-Way Active Vented Loudspeaker System			
Transducer Low	8"-2" voice coil	10"-2" voice coil	12"-2" voice coil	15"-2" voice coil
Transducer Driver	1" Ferrite Driver-1" Voice Coil			
Power System	600W Continuous (300W/LF+300W/HF) / 1200W Program / 2400W Peak Power, Class D			
Horn Coverage H° x V°	90°H x 60°V			
Frequency Response (-3dB)	65Hz-20KHz	60Hz-20KHz	55Hz-20KHz	50Hz-20KHz
Frequency Range (-10dB)	55Hz-20KHz	50Hz-20KHz	46Hz-20KHz	43Hz-20KHz
Max SPL (@1m)	123dB at 1m	125dB at 1M	127dB Max.	129dB Max.
Connector	1x XLR/F 1/4" Combo (Mic/Line) Input; 1x3.5 Stereo AUX IN, 1xStereo BT (App Control); 1x XLR/M(CH1 Link/Mix out) Output			
Controls	Volume Control / BT Pair and Link Switch / DSP Preset Switch / AC Power Switch			
Indicators	Signal/Clip Limiter LED, Four DSP Output Mode LEDs, BT Pair-Link LED, Power Switch LED			
DSP Preset Modes	LIVE-MUSIC-SPEECH-DJ			
Electronic Protections	Electronic Clip, Thermal and Transducer Overdrive Protection			
Power	110V-120V / 50-60Hz or 220V-240V / 50-60Hz			
Enclosure Construction	MDF Cabinet, Resistant Black Paint, Rubber Feet, Metal grille with Foam, handles			
Mounting	One Metal Standard Pole-Mount (36mm)			
Dimensions (HxWxD)	482 x 281 x 290 mm 18.9" x 11.1" x 11.4"	560 x 324 x 320 mm 22.0" x 12.8" x 12.6"	583 x 352 x 360 mm 22.9" x 13.9" x 14.2"	665 x 420 x 400 mm 26.2" x 16.5" x 15.7"
Net Weight	14.5 Kg / 31.9 lbs	18.8 Kg / 41.4 lbs	20.2 Kg / 44.5 lbs	25 Kg / 55.14 lbs

STARK 8A DSP

STARK 10A DSP

STARK 12A DSP

STARK 15A DSP



Active Wooden Speakers with DSP/BT

STARK DSP Series

NEW
MODEL

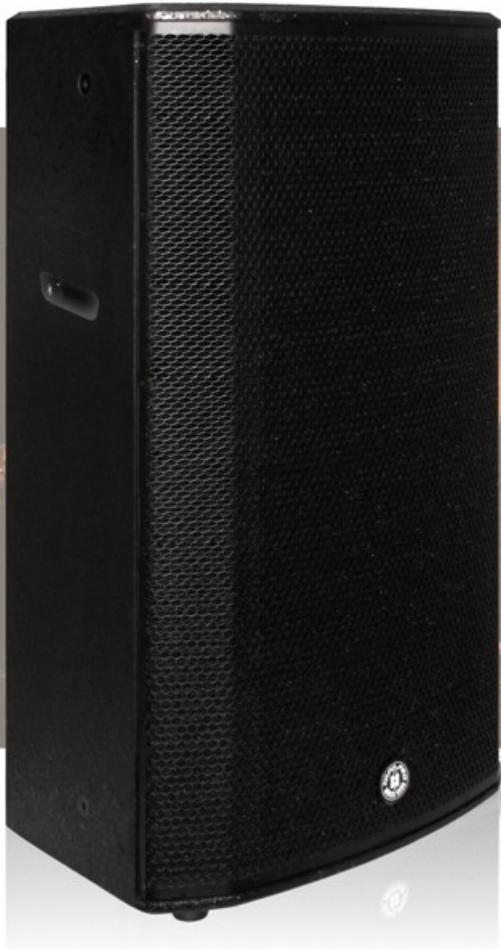

2400W **129dB** **CE**
TOTAL SYSTEM - PEAK POWER APPROVED



Stream music wirelessly from your smart device

Your Own Sound Calibration!

DSP Enhanced Bass Response
Stereo Bluetooth APP control
High-Efficiency Class D Amplifier



MAXHEB
POWER MODULE Optimum Headroom & SPL

Hi-Def
COMPONENTS

Rigging
READY!



STARK 8A DSP



STARK 10A DSP



STARK 12A DSP



STARK 15A DSP

MAXX DSP Series Subwoofer Technical Specifications

	MAXX 12SA DSP	MAXX 15SA DSP	MAXX 18SA DSP
System Type	Active Subwoofer Speaker Cabinet		
Transducer Low	12" Woofer - 3" Voice Coil	15" Woofer - 3" Voice Coil	18" Woofer - 3" Voice Coil
Output Power	1000W Continuous / 2000W Program / 4000W Peak Power, Class D		
Frequency Response (-3dB)	44Hz-100Hz	44Hz-85Hz	44Hz-86Hz
Frequency Range (-10dB)	38Hz-110Hz	37Hz-100Hz	35Hz-97Hz
Max SPL	129dB	131dB	133dB
Connections	2 x XLR + 1/4" Inputs; 2 x XLR Outputs		
Input Level	Line + 4dBu (nominal)		
External Controls	Volume Control / Output Mode Switch / Polarity-Reverse Switch / Deep-Frequency Switch, AC Power Switch		
Indicators	Signal / Clip Limiter LED, Four DSP Output Mode LEDs, Polarity-Reverse LED, Deep Frequency LED, Power Switch LED		
Electronic Protections	Electronic Clip, Thermal and Transducer Overdrive Protection		
Transducer	80Hz / 100Hz / 120Hz Low Pass Filter / Bypass Output Modes for Ideal Matching with Companion Speaker, Polarity Reverse Switch and Deep Switch for Increased EQ Control		
Enclosure Construction	MDF Cabinet, Resistant Black Paint, Rubber Feet, Metal Grille with Foam, Double handles		
Mounting	One Metal Standard Pole-Mount (36mm)		
Power Supply	110V-120V / 220-240V ~ 50-60Hz		
Dimensions (HxWxD)	456 x 459 x 505 mm 17.9" x 18.1" x 19.9"	542 x 523 x 628 mm 21.3" x 20.6" x 24.7"	680 x 533 x 628 mm 26.8" x 21" x 24.7"
Net Weight	25 Kg / 55.12 lbs	35.6 kg / 78.48 lbs	39.2 Kg / 86.4 lbs

MAXX 12SA DSP



MAXX 15SA DSP



MAXX 18SA DSP



Active Subwoofers with DSP

MAXX DSP Subwoofers

NEW
MODEL

4000W 133dB **CE**
TOTAL SYSTEM - PEAK POWER APPROVED

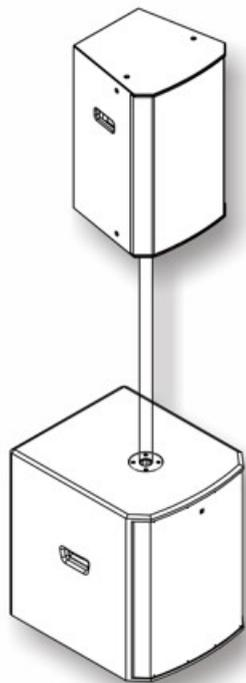

MAXHEB
POWER MODULE Optimum Headroom & SPL



High-Efficiency Class D Amplifier



MAXX 12SA DSP

3"
VOICE COIL



MAXX 15SA DSP

3"
VOICE COIL



MAXX 18SA DSP

3"
VOICE COIL

TPS Series Active Technical Specifications

TPS 16P

System Type	2-Way 6.5" Vented Passive Speaker Cabinet
Power Handling	RMS: 70 Watts / Program: 140 Watts 4Ω
Frequency Response	75Hz-20KHz (-6dB)
Sensitivity	110dB Max
X-over Frequency	2.4KHz @12dB/oct
Low Frequency	6.5" Woofer / 1" Voice Coil
High Frequency	1" Neodymium Tweeter
Enclosure	Trapezoidal painted wood cabinet.metal grille
Point	4 x M4 Standard (2 x Vertical and Horizontal side)
Dimensions (HxWxD)	318 x 200 x 202 mm / 12.52" x 7.87" x 7.95"
Net Weight	4.2 Kg / 9.26 lbs

TPS 16AP

System Type	2-Way 6.5" Vented Active Speaker Cabinet
Power Handling	RMS: 70Watts / Program: 140Watts
Frequency Response	75Hz-20KHz (-6dB)
Sensitivity	110dB Max
X-over Frequency	2.4KHz@12dB/oct
Low Frequency	6.5" woofer / 1" Voice Coil
High Frequency	1" Neodymium Tweeter
Connectors	MIC/LINE balanced input -40/0dB (Combo Connector), AUX input -10dB with RCA Connector, LINK Output -40/0dB with XLR
Amplifier	Class-D 70Wx2 (BTL)
Electronic Protections	Thermal / overload / analog limiter
Volume Control	Continuous, work only on MIC/LINE input
Power Supply	110-120V / 220-240V~50/60Hz
Enclosure	Trapezoidal painted wood cabinet.metal grille
Flying Point	4 x M4 Standard (2 x Vertical and Horizontal side)
Dimensions (HxWxD)	318 x 200 x 202 mm / 12.52" x 7.87" x 7.95"
Net Weight	4.6 Kg / 10.14 lbs

TPS 16AM.UB

System Type	2-Way 6.5" Vented Active Speaker Cabinet
Power Handling	RMS: 140Watts / Program: 280Watts
Frequency Response	75Hz-20KHz (-6dB)
Sensitivity	110dB Max
Low Frequency	6.5" woofer / 1" Voice Coil
High Frequency	1" Neodymium Tweeter
X-over Frequency	2.4KHz@12dB/oct
Mixer	2-band equalizer on input channels, 5 Input channels with individual Volume control, 3 bands Master EQ, 3 COMBO microphone Inputs with phantom power, 2 RCA Line Inputs/3.5mm jack, 2 RCA Line Outputs, Monitor output with level control, Powered output 70W (@4 Ohm, min) for optional external speakers, 16-preset digital effect processor
USB Player	USB & Micro SD Card, Bluetooth
Power Supply	230V - 115V @50 - 60Hz
Amplifier	Class-D 70W x 2, one for inside speaker / one for optional external speaker
Electronic Protections	Thermal / overload / analog limiter
Enclosure	Trapezoidal painted wood cabinet. metal grille
Flying Point	4 x M4 Standard (2 x Vertical and Horizontal side)
Dimensions (HxWxD)	318 x 200 x 220 mm / 12.52" x 7.87" x 8.66"
Net Weight	6.2 Kg / 13.67 lbs



	TPS10MA	TPS12MA
System Type	2-Way Bi-Amp Active Monitor Speaker, with DSP	
Power Rating	830W PROGRAM / 1660W PEAK	
Frequency Response	68Hz - 20KHz (-6dB)	60Hz - 20KHz (-6dB)
Speaker Sensitivity (1m)	94dB / 120dB Max.	95dB / 121dB Max.
Low Frequency	10" Woofer / 2" Voice Coil, with ventilation	12" Woofer / 2" Voice Coil, with ventilation
High Frequency	1" Driver / 1" Voice Coil	
Horn Coverage (H x V)	70° x 70°	
Enclosure	Trapezoidal Shape, MDF WOOD Black Paint, Handle, metal grille, rubber feet	
Input connectors	Input with Combo / Link with XLR	
External Controls	Volume Control / Power ON Volume Control / Power ON with Green LED / Clip Limiter with Red LED / Ground Lift	
Input Impedance	30 K Ohm Balanced / 15K Ohm Unbalanced	
Preset	FOH / Monitor	
Input Sensitivity	Line - 6dBu	
Protection Low-High	Analog Limiter	
Indicator	Power / Clip	
Power Supply	110V-120V~50/60Hz, 220V-240V~50/60Hz Switchable	
Dimension (HxWxD)	273 x 362 x 368 mm / 10.75" x 14.25" x 14.49"	313 x 393 x 513 mm / 12.32" x 15.47" x 20.20"
Net Weight	11.65 Kg / 25.68 lbs	13.89 Kg / 30.62 lbs



TPS Series

280W 122dB **CE**
TOTAL SYSTEM - PEAK POWER APPROVED



ACTIVE MONITOR WITH MIXER **TPS16AM.UB**

140W 113dB **CE**
TOTAL SYSTEM - PEAK POWER APPROVED



INSTALL SYSTEM **TPS16P / TPS16AP**



Active Monitor with Mixer
1" Neodymium Driver
MP3 / USB / BLUETOOTH



AP Active Output
Powers TPS 16P Passive

830W 121dB **CE**
TOTAL SYSTEM - PROGRAM POWER APPROVED



1" HD Driver

2 User-Selectable Settings:
Monitor & Satellite FOH



TPS 10MA



TPS 12MA

TMA-4150ZBT / TAP Airport Series Technical Specifications

TMA-4150ZBT

Rated Output Power	Sine Wave 1KHz, THD≤1%, LOAD 4Ω	150Wx4
Sensitivity / Impedances	MIC (Balanced): -40dBv	AUX (Unbalanced): -10dBv
	LINE (Balanced): -10dBv	TEL.: -10dBv
Max. Input Level	MIC (Balanced): -20dBv	AUX (Unbalanced): +10dBv
	LINE (Balanced): +15dBv	TEL.: +0dBv
S/N Ratio	MIC:>70dB	AUX: >80dB
	Line:>80dB	TEL.: >70dB
THD+N	1W / RMS	≤-1%
Tone Control	BASS@100Hz	±10dB
	TREBLE@1KHz	±10dB
Phantom Supplu	MIC (Balanced)	18V
Priority Sensitivity	MIC1	-60dBv / 3S
CMRR	Balance input	>60dB
Crosstalk	500-20KHz	<-60dB
Noise	All VR MAX	<20mv
Phase	All of inputs and outputs	<±5
Rated Power Consumption	Sine Wave 1KHz, THD≤1%, LOAD 4Ω	750W
AC Power Supply	110-120V~, 220-240V~50/60Hz	

	TAP20T	TAP40T	TAP20A	TAP40A
System Type	Speaker cabinet with transformer		Active speaker cabinet	
Continuous Power	70V: 20W / 10W / 5W / 2.5W 100V: 20W / 10W / 5W	70V: 40W / 200W / 10W / 5W 100V: 40W / 20W / 10W	20W	30W RMS
SPL (1w/1m)	85dB (±3dB)	90dB (±3dB)	85dB (±3dB)	90dB (±3dB)
Impedance	70V: 245Ω / 500Ω / 1KΩ / 2KΩ 100V: 500Ω / 1KΩ / 2KΩ	70V: 122Ω / 250Ω / 500Ω / 1KΩ 100V: 250Ω / 500Ω / 1KΩ	4 Ω	
Speaker	3" Full range speaker 0.8" Voice Coil	4" Full range speaker 1" Voice Coil	3" Full range speaker 0.8" Voice Coil	4" Full range speaker 1" Voice Coil
External Controls	Power selective switch		Volume control / Power switch	
Frequency	132Hz	76Hz	132Hz	76Hz
Response	20KHz	18KHz	20KHz	18KHz
Connectors	Wiring terminal		Input - RCA and Ø6.3mm Balanced / Output - link Ø6.3mm Jack	
Power Supply	-		100 - 120V~60Hz / 210 - 240V~50Hz	
Dimension (HxWxD)	115 x 107 x 175 mm 4.53" x 4.21" x 6.89"	136 x 140 x 206 mm 5.35" x 5.51" x 8.11"	115 x 107 x 175 mm 4.53" x 4.21" x 6.89"	136 x 140 x 206 mm 5.35" x 5.51" x 8.11"
Net Weight	1.12 Kg / 2.47 lbs	2.30 Kg / 5.07 lbs	1.34 Kg / 2.95 lbs	2.40 Kg / 5.29 lbs

Installation Ready!



TMA-4150ZBT / TAP Airport Series

750W CE APPROVED
TOTAL SYSTEM - PEAK POWER



5 Channel Mixer / 4 Zones

Frequency Response: 60-17KHz (-3dB)
Treble: 10dB at 10KHz / Bass: 10dB at 100Hz

Priority for Mic-1

Output Constant Voltage: 25V, 70V & 100V

8 Volume Controls for: Ch1-5, Tel. Paging, Monitor & Phone



TAP20T

TAP20A

TAP40T

TAP40A



3" Full range speaker / 0.8" Voice Coil

4" Full range speaker / 1" Voice Coil



TAP Series Technical Specifications

TAP-60

Power output (1K / 70V / 100V)	60W (RMS)
Frequency response	80Hz- 16KHz (±3dB)
T.H.D.	1±1%
S/N Ratio	Mic: ≥65dB / Phantom: ≥65dB / Line: ≥75dB / AUX: ≥75dB
Input / Sensitivity	Mic: -52dBV balanced / Phantom: -52dBV / 18V balanced / Line: -10dBV balanced / AUX: -10dBV balanced / Test/alarm: -10dBV balanced
Equalizer Controls	BASS: ±10dB (at 100Hz), TREBLE: ±10dB (at 10KHz)
Indicators	Power: Green led / Signal: Green led / Pro: Red led / Clip : Red led
Output	COM, 4 Ohm, 70V / 100V Class-D amplifier
Controls	4 input volume controls, 1 Aux volume control / 2 Treble / Bass controls, 1 Master volume control / 4 Mic / Phantom / Line selector switch / 1 Mic / Priority controls / MP3 player with SD/USB interface / ECHO function
Power supply	AC 100-240V 50/60HZ / DC24V
Dimensions (WxDx H)	483 x 281 x 44 mm / 19.02" x 11.06" x 1.73"
Net weight	4.1 Kg / 9.04 lbs

TAP-120

Power output (1K / 70V / 100V)	120W (RMS)
Frequency response	80Hz- 16KHz (±3dB)
T.H.D.	1±1%
S/N Ratio	Mic: ≥65dB / Phantom: ≥65dB / Line: ≥75dB / AUX: ≥75dB
Input / Sensitivity	Mic: -52dBV balanced / Phantom: -52dBV / 18V balanced / Line: -1 OdBV balanced / AUX: -1 OdBV balanced / Test/alarm: -10dBV balanced
Equalizer Controls	BASS: ±10dB (at 100Hz), TREBLE: ±10dB (at 10KHz)
Indicators	Power: Green led / Signal: Green led / Pro: Red led / Clip : Red led
Output	COM, 4 Ohms, 70V, 100V Class-D amplifier
Controls	4 input volume controls, 1 Aux volume control / 2 Treble / Bass controls, 1 Master volume control / 4 Mic / Phantom / Line selector switch / 1 Mic / Priority controls / MP3 player with SD/USB interface / ECHO function
Power supply	AC 100-240V 50/60HZ / DC24V
Dimensions (WxDx H)	483 x 281 x 44mm / 19.02" x 11.06" x 1.73"
Net weight	4.9 Kg / 10.8 lbs

TAP-240

Power output (1K / 70V / 100V)	240W (RMS)
Frequency response	80Hz- 16KHz (±3dB)
T.H.D.	1±1%
S/N Ratio	Mic: ≥65dB / Phantom: ≥65dB / Line: ≥75dB / AUX: ≥75dB
Input / Sensitivity	Mic: -52dBV balanced / Phantom: -52dBV / 18V balanced / Line: -1 OdBV balanced / AUX: -1 OdBV balanced / Test/alarm: -10dBV balanced
Equalizer Controls	BASS: ±10dB (at 100Hz), TREBLE: ±10dB (at 10KHz)
Indicators	Power: Green led / Signal: Green led / Pro: Red led / Clip : Red led
Output	COM, 4 Ohm, 70V, 100V Class-D amplifier
Controls	4 input volume controls, 1 Aux volume control / 2 Treble / Bass controls, 1 Master volume control / 4 Mic / Phantom / Line selector switch / 1 Mic / Priority controls / MP3 player with SD/USB interface / ECHO function
Power supply	AC 100-240V 50/60HZ / DC24V
Dimensions (WxDx H)	483 x 281 x 44mm / 19.02" x 11.06" x 1.73"
Net weight	5.6 Kg / 12.35 lbs



TAP Series



TAP-60

60W CE
TOTAL SYSTEM - RMS POWER APPROVED



TAP-120

120W CE
TOTAL SYSTEM - RMS POWER APPROVED



TAP-240

240W CE
TOTAL SYSTEM - RMS POWER APPROVED



2 Tones (BASS/TREBLE)

5 Input volume controls / 1 Master

MP3 player with SD/USB interface

Constant voltage output is 70V / 100V

Output level display

4 MIC (XLR) inputs

MIC / LINE / PHANTOM exchange SW

1 AUX (RCA) Input ECHO Function



TAP-240
Rear View

WRS Series Technical Specifications

WRS-5 & WRS-5W

System	2-Way Passive Speaker Cabinet
Type Standard	Loudspeaker for voice alarm systems for fire detection and fire alarm system
Environment Type	Type B (Outdoor applications)
Transducer Low	5" ferrite woofer, 1" voice coil
Transducer Driver	1" Neodymium Tweeter
Rated Noise Power	40W (100V and 70V line)
Rated	100V line: 250 Ohm (40W) / 500 Ohm (20W) / 1K Ohm (10W) / 2K Ohm (5W)
Impedance	70V Line: 122 Ohm (40W) / 250 Ohm (20W) / 500 Ohm (10W) / 1K Ohm (5W) Bypass: 8 Ohm
Sensitivity	500Hz-5KHz pink noise: 85dB (1W, 1m)
Max SPL	97dB (40W, 1m)
Coverage Angle (H x V)	500Hz: 360° x 360° / 1kHz: 188° x 140° / 2kHz: 92° x 58° / 4kHz: 128° x 165°
Protection Rate	IP55
Cable Connection	Steatite terminal x 2 speaker cable (Ø 6.6mm)
Finish	Enclosure: ABS + PC / Mesh speaker grill: surface-treated steel plate Speaker Wall bracket: surface-treated steel plate, painted joint bracket, screw and stainless steel cable
Dimensions (HxWxD)	278 x 170 x 172 mm / 10.9" x 6.7" x 6.8"
Net Weight	3.1 Kg / 6.83 lbs

WRS-8 & WRS-8W

System	2-Way Passive Speaker Cabinet
Type Standard	Loudspeaker for voice alarm systems for fire detection and fire alarm system
Environment Type	Type B (Outdoor applications)
Transducer Low	8" ferrite Woofer, 1,2" voice coil
Transducer Driver	1" Neodymium Tweeter
Rated Noise Power	80W (100V and 70V line)
Rated	100V line: 125 Ohm (80W) / 250 Ohm (40W) / 500 Ohm (20W) / 1K Ohm (10W)
Impedance	70V Line: 62 Ohm (80W) / 125 Ohm (40W) / 250 Ohm (20W) / 500 Ohm (10W) Bypass: 8 Ohm
Sensitivity	500Hz-5KHz pink noise: 87dB (1W, 1m)
Max SPL	105dB (80W, 1m)
Coverage Angle (H x V)	500Hz: 162° x 140° / 1KHz: 114° x 123° / 2KHz: 171° x 52° / 4KHz: 131° x 97°
Protection Rate	IP55
Cable Connection	Steatite terminal x 2 speaker cable (Ø 6.6mm)
Finish	Enclosure : ABS + PC / Mesh speaker grill : surface-treated steel plate Speaker Wall bracket: surface-treated steel plate, painted joint bracket, screw and stainless steel cable
Dimensions (HxWxD)	406 x 250 x 251 mm / 16" x 9.8" x 10"
Net Weight	6.4 Kg / 14.1 lbs



U-Bracket



MB01-Bracket



(Optional brackets)



WRS Series

40W **87dB** **CE**
TOTAL SYSTEM - RATED NOISE POWER APPROVED

80W **92dB** **CE**
TOTAL SYSTEM - RATED NOISE POWER APPROVED



WRS-5W
5" Ferrite Woofer /
1" Voice Coil
1" Neodymium Tweeter



8" Ferrite Woofer /
1.2" Voice Coil
1" Neodymium Tweeter
WRS-8



WRS-5

5"

WOOFER



WRS-5W

5"

WOOFER



WRS-8

8"

WOOFER



WRS-8W

8"

WOOFER

Wireless Systems Technical Specifications

KTX / KRX

Channel	16 presets frequency channel. (0~9 , A~F)
Frequency band	UHF 470-960MHz Dependent on applicable country regulations
Oscillation mode	PLL UHF Synthesized
Frequency response	30Hz-17KHz (± 3 dB)
Frequency stability	$\pm 0,005\%$ (-10 - 50)
T.H.D	1KHz<0.3%
Modulation mode	FM (F3E)
S/N Ratio	KTX:>100dB / KRX:>98dB
R/F output power	KTX: 10mW
R/F sensitivity	KRX: -100dBm/12dB SINAD
Balance output	KRX: 1V, 40KHz deviation
Max. Deviation	KTX: 50KHz
Power supply	AA (LR6) 1.5V

TMW U1.100R

Channel	Single, 100 Frequencies
Receiver Type	True Diversity PLL Synthesized
Frequency Band	UHF 470-900MHz
Modulation	FM (F3E)
Frequency Response	50Hz - 15KHz (± 3 dB)

TMW U2.100R -Half rack-

Channel	Dual, 100 Frequencies per channel. 200 Total
Receiver Type	Dual Receiver PLL Synthesized
Frequency Band	UHF 470-900 MHz
Modulation	FM (F3E)
Frequency Response	50Hz - 15KHz (± 3 dB)

TMW U2.200R

Channel	Dual, 100 Frequencies per channel. 200 Total
Receiver Type	Dual Receiver PLL Synthesized
Frequency Band	UHF 470-900 MHz
Modulation	FM (F3E)
Frequency Response	50Hz - 15KHz (± 3 dB)

BT-STR

Bluetooth Version	Bluetooth V4.0
Bluetooth protocol	AVCTP 1.0, AVRCP 1.0, GAVDP 1.2, AVDTP 1.0, A2DP 1.2, Hands-Free Profile 1.5, Headset Profile V1.1
Max Transmit Power	Class 2 4dBm
Receive Sensitivity	-80dBm@0.1%BER
Frequency	2.4GHz - 2.480GHz
Audio performance	High acoustic fidelity sound
SNR	≥ 75 dB
THD	$\leq 0.01\%$
Power Supply	AC 9V ADAPTOR

TMW U1.100P

Channel	Dual, 100 Frequencies per channel. 200 Total
Receiver Type	Dual Receiver PLL Synthesized
Frequency Band	UHF 470-900 MHz
Modulation	FM (F3E)
Frequency Response	50Hz - 15KHz (± 3 dB)

TMW U1.100T

Frequency band	UHF 470-900MHz
Oscillation Mode	PLL UHF Synthesized
RF Radiation FCC	10mW
Battery	"AA" type x 2pcs (used for more than 6 hours)
Microphone Capsule	Dynamic Capsule
Frequency Response	50Hz-15KHz (± 3 dB)

Up to 300ft Range!

TMW U1.100
TMW U2.100
TMW U2.200



M Pack Wireless System includes:
Receiver and Hand held Microphone



LTHSGT Pack Wireless System includes:
Receiver, Beltpack, Headset, Mic Lavalier and Guitar cable



Wireless Systems

BT-STR 4.0 Bluetooth Stereo Receiver



any Mixer!

Pair Bluetooth device!

PLAY!

KRX / KTX Modules

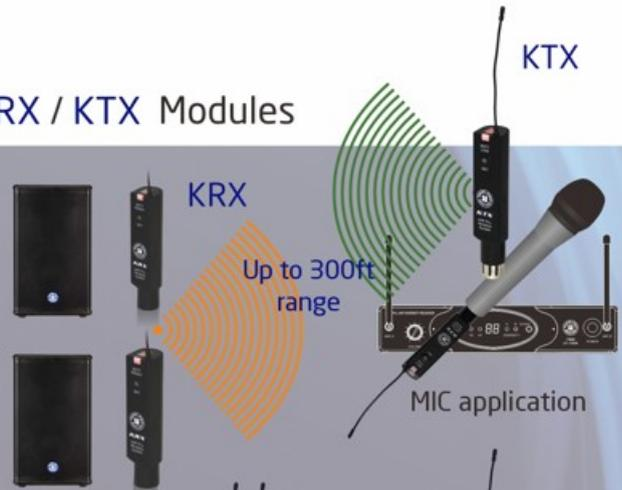

Up to 300ft range

MIC application

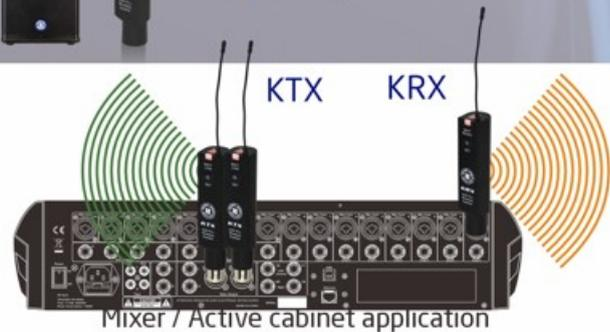

Mixer / Active cabinet application

TMW U2.100M / LTHSGT



PLL UHF SYNTHESIZED

100 FREQUENCIES PER CHANNEL PLL UHF SYNTHESIZED

TMW U2.200M / LTHSGT



100 FREQUENCIES UHF DIVERSITY PLL UHF SYNTHESIZED

TMW U1.100M / LTHSGT

TRX / TDX Series Technical Specifications

		TRX2500	TRX4000	TRX5000	TRX6000
Stereo Mode	8 Ohms Continuous	350W x 2	650W x 2	1200W x 2	1400W x 2
	4 Ohms Continuous	500W x 2	1000W x 2	1850W x 2	2100W x 2
	2 Ohms Program / Peak	750W x 2	1400W x 2	2100W x 2	2900W x 2
Bridge Mode	8 Ohms Continuous	950W	1800W	3600W	4000W
	4 Ohms Continuous	1500W	2300W	4000W	6000W
Dimensions (HxWxD)		88 x 483 x 470 mm 3.47" x 19.02" x 18.50"	88 x 483 x 470 mm 3.47" x 19.02" x 18.50"	132 x 483 x 470 mm 5.20" x 19.02" x 18.50"	132 x 483 x 470 mm 5.20" x 19.02" x 18.50"
Net Weight		15 Kg / 33.07 lbs	20 Kg / 44.09 lbs	38Kg / 83.78 lbs	38 Kg / 83.78 lbs

Common Specifications: Single to Noise Ratio A-weighted: >100dB, Residual Noise, A-weighted: <70dBu, Input Sensitivity: 1.2V, Total Harmonic Distortion: <0.05%, Crosstalk ref. 1kHz at rated output power: > 60dB, Frequency Response: 20Hz~20KHz ±0.5dB at 10dB below rated output power, all models, Input Impedance: 10KOhms Unbalanced, 20KOhms balance, all models, Damping Factor, 1kHz: >500 at 8 Ohms, all models, Slew Rate: 40V/μs, Power Requirements: 100V, 120V, 220V, 230V, 240V, 50/60Hz (factory configured), Protections: Turn-on delay, Over-heat, Short-circuit, DC, overcurrent, mismatched loads.

TDX8000 Digital Amplifier

Power (Both channels Driven)	2000W x 2 (RMS) @4 Ohms
Input Sensitivity (Limiter Off)	0.9 - 1.1V (+0/-1dBv)
Input Impedance	20K Ohms balanced or 10K Ohm unbalanced
Frequency Response (At 10dB below Rated Output Power)	20Hz~20KHz (+0/-1dB)
Voltage Gain	40dB (+/-0.5dB)
THD + N	<0.1% (Ref. 1kHz 1/8 Rated Power, A-Weighted)
S/N Ratio	>100dB (Ref. 1kHz, A-Weighted)
Power / Output Circuitry	Switching Power Class-D
Protections	Full short circuit, open circuit, thermal, ultrasonic, and RF protection stable into reactive or mismatched loads, turn ON/OFF, muting, tripped crowbar
Controls	Front: AC switch (soft-start), Input level control / Rear: stereo, parallel selector
Indicators	POWER & SIGNAL: 2 green LED / CLIP & PROTECTION: 2 red LED
Connectors	Inputs: NEUTRIK COMBO XLR/TRX / Outputs: SPEAKON
Power Supply	AC: 110-120V or 220~240V 50/60Hz
Dimension (HxWxD)	88 x 483 x 360 mm / 3.47" x 19.02" x 14.17"
Net Weight	5.0 Kg / 11.02 lbs

TRX / TDX Series

**BEST
SELLER**



TRX2500

D+V+S
Dual Ventilation System



TRX4000

D+V+S
Dual Ventilation System



TRX5000

D+V+S
Dual Ventilation System



TRX6000

D+V+S
Dual Ventilation System



TDX8000

D+V+S
Dual Ventilation System



TRX5000
TRX6000

TRX2500
TRX4000



TDX8000

LVA Series Technical Specifications

LVA4.150

Power (Both channels driven)	2Ω (EIAJ): 360W x 4 4Ω (RMS): 150W x 4 8Ω (RMS): 90W x 4
Bridge Mono Mode	4Ω (RMS): 400W 8Ω (RMS): 310W
Input Sensitivity (Limiter Off)	0.9 - 1.1V (+0/-1dBv)
Input Impedance	20K Ohm balanced or 10K Ohm unbalanced
Frequency Response	20Hz~20KHz (+0/-1dB) (At 10dB below Rated Output Power)
Voltage Gain	28 (+/-0.5dB)
THD + N	<0.1% (1KHz 1/8 Rated Power, A-Weighted)
S/N Ratio (Ref. 1KHz, A-Weighted)	> 96dB
Crosstalk (Below Rated Power)	> 70dB
Damping Factor (1KHz, 8W)	> 200
Power/Output Circuitry	Switching Power Class-D
Protections	Full short circuit, open circuit, thermal, ultrasonic, and RF protection stable into reactive or mismatched loads, turn ON/OFF, muting, tried crowbar
Controls	Front: On/Off Power Switch, Volume Channel A, B, C, D - Rear : 8 preset modes
Indicators	POWER: 1 blue - PROTECTION & CLIP: 4 red - SIGNAL: 4 green LED
Connectors	Inputs: Euro block - Outputs: Euro block
Power Supply	AC: 110-120V or 220~240V 50/60Hz
Dimension (HxWxD)	44 x 483 x 360 mm / 1.73" x 19.02" x 14.17"
Net Weight	4.6 Kg / 10.14 lbs

	LVA8.150	LVA16.150
Power (Both channels driven)	4Ω (RMS) : 130W x 8 8Ω (RMS) : 70W x 8	4Ω (RMS) : 130W x 16 8Ω (RMS) : 70W x 16
Input Sensitivity (Limiter Off)	0.9 - 1.1V (+0/-1dBv)	
Input Impedance	20K Ohm balanced or 10K Ohm unbalanced	
Frequency Response	20Hz~20KHz (+0/-1dB)	
Voltage Gain	28 (+/-0.5dB)	
THD + N	<0.1% (1KHz 1/8 Rated Power, A-Weighted)	
S/N Ratio (Ref. 1KHz, A-Weighted)	> 95dB	
Crosstalk (Below Rated Power)	> 70dB	
Damping Factor (1KHz, 8W)	> 200	
Power/Output Circuitry	Switching Power Class-D	
Protections	Full short circuit, open circuit, thermal, ultrasonic, and RF protection stable into reactive or mismatched loads, turn ON/OFF, muting, tried crowbar	
Controls	Front: On/Off Power Switch - Rear: Volume Channel 1 to 8	
Indicators	SIGNAL: 8 green / LED / CLIP: 8 red LED / Power: 1 green LED / Protection: 8 red / LED	SIGNAL: 16 green / LED / CLIP: 16 red LED / Power: 1 green LED / Protection: 16 red / LED
Connector	Inputs: Euro Block - Outputs: Euro Block	
Power Supply	AC: 110-120V or 220~240V 50/60Hz	
Dimension (HxWxD)	44 x 483 x 360 mm / 1.73" x 19.02" x 14.17"	
Net Weight	6.3 Kg / 13.89 lbs	6.8 Kg / 14.99 lbs

LVA Series



LVA4.150



LVA8.150



LVA16.150



LVA4.150



LVA8.150



LVA16.150

HVA Series Technical Specifications

		HVA4.150	HVA8.150
Power 70V (RMS)	One Channel Driven	150W	150W
	All Channel Driven	135W x 4	135W x 8
Power 100V (RMS)	One Channel Driven	150W	150W
	All Channel Driven	135W x 4	135W x 8
Input Sensitivity (Limiter Off)		0.9 - 1.1V (+0/-1dBv)	
Input Impedance		20K Ohm balanced or 10K Ohm unbalanced	
Frequency Response		100Hz~15KHz (+0/-3dB) (At 10dB Below Output Power)	100Hz-15KHz (+0/-1dB)
Voltage Gain (100V)		40 (+0/-1dB)	40dB
THD + N		<0.1% (Ref. 1KHz 1/8 Rated Power, A-Weighted)	
S/N Ratio		>95dB (Ref. Rated Power, A-Weighted)	
Crosstalk (Below Rated Power)		>70dB	
Damping Factor (1KHz, 8W)		>200	
Power/Output Circuitry		Switching Power Class-D	
Protections Full short circuit, open circuit, thermal, ultrasonic, and RF protection stable into reactive or mismatched loads, turn ON/OFF, muting, tried crowbar.			
Controls		Front: On/Off Power Switch, Volume Channel A, B / Rear 70/100V selector	Rear: On/Off Power Switch, Volume Channel 1 to 8, 70V/ 100V selector
Indicators		SIGNAL: 4 green LED - CLIP & PROTECTION 4 red LED / POWER: 1 green LED	POWER: 1 green LED - PROTECTION: 2 red LED - SIGNAL: 8 green LED CLIP & PROTECTION: 8 red LED - POWER: 1 green LED
Connectors		Inputs: Euro Block - Outputs: Euro Block	
Power Supply		AC: 110-120V or 220-240V 50/60Hz	
Dimension (HxWxD)		44 x 483 x 360 mm / 1.73" x 19.02" x 14.17"	
Net Weight		5.4 Kg / 11.91 lbs	

HVA4.500

Power 70V (RMS)	One Channel Driven	480W
	All Channel Driven	400W x 4
Power 100V (RMS)	One Channel Driven	480W
	All Channel Driven	400W x 4
Input Sensitivity (Limiter Off)		0.9 - 1.1V (+0/-1dBv)
Input Impedance		20KΩ balanced or 10KΩ unbalanced
Voltage Gain		40 (+0/-0.5dB)
Frequency Response		100Hz~15KHz (0+/-3dB)
THD+N		<0.1% (Ref. 1K 1/8 Rated Power, A-weighted)
S/N Ratio		>95dB
Crosstalk		>70dB
Damping Factor		>200
Protections Full short circuit, open circuit, thermal, ultrasonic and RF protection stable into reactive or mismatched loads, turn ON/OFF, muting, tried crowbar		
Controls Front: ON/OFF Power switch, Volume Control Rear: 70/ 100V Selector		
Indicators SIGNAL: 4 Green LED / CLIP: 4 Red LED / POWER: Green LED / PROTECTION: 4 Red LED		
Connectors Euroblock		
Power Supply AC:100-120V or 220-240V 50/60Hz		
Dimension (HxWxD) 483 x 360 x 44 mm / 19.02" x 14.17" x 1.73"		
Net Weight 6.3kg / 13.89 lbs		

		HVA1000.2	HVA1500.2
Stereo Mode (All Channel Drive)	2Ω (EIAJ) 2000W x 2		2Ω (EIAJ) 2800W x 2
	4Ω (RMS) 900W x 2		4Ω (RMS) 1500W x 2
	8Ω (RMS) 600W x 2		8Ω (RMS) 900W x 2
Bridge Mono Mode	4Ω (EIAJ) 1800W		4Ω (EIAJ) 4000W
	8Ω (RMS) 1000W		8Ω (RMS) 1800W
Input Sensitivity (Limiter Off)		0.9 - 1.1V (+0/-1dBv)	
Input Impedance		20KΩ balanced or 10KΩ unbalanced	
Voltage Gain		37 (+0/-0.5dB)	
Frequency Response (4Ω)		20Hz~20KHz (0+/-1dB)	
THD+N		<0.1% (Ref. 1K 1/8 Rated Power, A-Weighted)	
S/N Ratio		>100dB	
Crosstalk		>70dB	
Damping Factor		>200	
Protections Full short circuit, open circuit, thermal, ultrasonic and RF protection stable into reactive or mismatched loads, turn ON/OFF, muting, tried crowbar			
Controls Front: ON/OFF Power switch, VolumeChannel A,B, Rear: STEREO-PARALLEL-BRIDGE-70/ 100V-MUTE Selector			
Indicators SIGNAL: 2 Green LED / CLIP: 2 Red LED / POWER: Green LED / PROTECTION: 1 Red LED / Bridge: 1 Red LED			
Connectors Input: Active balanced XLR or TRS JACK / OUTPUT: TRS and speak-on			
Power Supply AC:100-120V or 220-240V 50/60Hz			
Dimension (HxWxD)		483 x 360 x 44 mm / 19.02" x 14.17" x 1.73"	483 x 446 x 44 mm / 19.02" x 17.56" x 1.73"
Net Weight		5.7kg / 12.57 lbs	6.1kg / 13.45 lbs



HVA Series



HVA4.150
(70V / 100V)



HVA8.150
(70V / 100V)



HVA4.500



HVA1000.2



HVA1500.2



HVA4.500



HVA1000.2
HVA1500.2

HVA4.150



HVA8.150

DLM408 PLUS & DLM808 Technical Specifications

DLM408 PLUS

Microphone input	Electronically balanced
Frequency Response to Main Output	20Hz~20KHz at 0dBu +/-3dB
Distortion (THD&N) to Main Output	<0.01% at 0dBu 1KHz
SNR (Signal to Noise Ratio)	108dB
Maximum Input Level	+20dBu
Maximum Output Level	+20dBu
Crosstalk, Input to Output	-90dBu
Crosstalk, Adjacent Channels	-90dBu
Noise Gate, Threshold Range	-80dBu - +20dB
Noise Gate, Attack time	10mS~150mS
Noise Gate, Release time	10mS~1S
Noise Gate, Ratio	1.0:1 to 10:1
Compressor, Threshold Range	-30dBu~+20dB
Compressor, Attack time	10mS ~ 150mS
Compressor, Release time	10mS~1S
Compressor, Ratio	1:1 to 10:1
Gain	0dB~ +24dB
EQ Low (Low Pass or Low Shelf)	19.7Hz~20.1KHz +/-18dB
EQ Low Mid	19.7Hz~20.1KHz +/-18dB
EQ High Mid	19.7Hz~20.1KHz +/-18dB
EQHigh (High Pass or High Shelf)	19.7Hz~20.1KHz +/-18dB
Impedances	10K Ohm
DSP Processor	32-bit, floating point
Sample Rate	48K/24bit
Power Supply	100-240V~50/60Hz

DLM808 PLUS

Microphone input	Electronically balanced
Frequency Response to Main Output	20Hz~20KHz at 0dBu +/-1dB
Distortion (THD&N) to Main Output	<0.01% at 0dBu 1KHz
SNR (Signal to Noise Ratio)	110dB
Maximum Input Level	+20dBu
Maximum Output Level	+20dBu
Input to Output & Adjacent Channels	-87dBu
Noise Gate, Threshold Range	-87dBu
Noise Gate, Attack time	-84dBu -0dB
Noise Gate, Release time	0.5mS~200mS
Compressor	5mS~2S
Threshold Range	-30dBu - +20dB
Attack time	10mS~150mS
Release time	10mS~1 S
Ratio	1:1 to 24:1
Gain	0dBu - +24dB
EQ-Low (Low Pass or Low Shelf)	21Hz~19.2KHz +/-24dB
Low Mid / High Mid	21Hz~19.2KHz +/-24dB
High (High Pass or High Shelf)	21Hz~19.2KHz +/-24dB
ADC/DAC Dynamic Range	114dB
DSP Processor	32-bit, floating point
Sample Rate	48K/24bit
Power Supply	100-240V~50/60Hz

Control More...
Better!



Dante
Optional Digital Card





DLM408 PLUS & DLM808

DLM408 PLUS



4 XLR Inputs 8 XLR Outputs



DLM808



8 XLR Inputs 8 XLR Outputs



Digital & Analog Processors Technical Specifications

TX0-234MKII

Crossover 2 and 3 way stereo, 4 way mono crossover, Delay effect, Available in 110V or 220V, 1 rack unit.

TLINK-8

SPLIT / MIX switch for each mono channel, 2 inputs, 6+2 outputs splitter, 8 balance / Pan control for each channel, main input and output level control, MAIN LINK function allows to route the MAIN IN signal to MAIN OUT, viceversa, level meters for each stage, XLR balanced connectors for 4 mono channels, and TRS type for another 2 mono channels, 1 rack unit.

THA-6

6 channel headphones amplifier, In: XLR and 1/4" jack, RF filtered, servo balanced input, Out: XLR and 1/4" Jack, balanced / unbalanced, 10Hz to 50KHz, +/-3 dB, available in 110V or 220V, 1 rack unit.

TEQ-231SW

2 x 31 band graphic equalizer, subwoofer out, In/Out XLR & TRS, LEDs lights up on faders, 2 rack units.

TDI-A2

Active direct box, 1/4" TRS or XLR, electronically unbalanced, input +12dBu, PAD switch: two 20dB PAD SW, output: 47K Ohm electronically balanced, XLR 120 Ohm output, Freq. response: +/-2dB @1KHz, THD <0.03%, power source: 9V battery or 48V Phantom Power.

TDI-P1

Passive direct box, In: 1/4" TRS electronically unbalanced, discrete input configuration, out: electronically balanced XLR, max. input +22dBu, frequency response: +/-1dB @1KHz.



TDI-A2

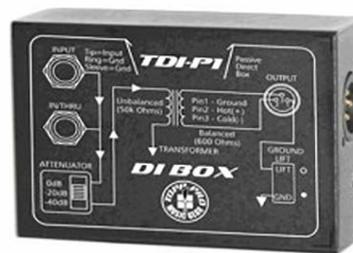

TDI-P1



Digital & Analog Processors

**BEST
SELLER**



TXO-234 MKII



T-LINK 8



THA-6



TEQ-231SW



TDI-A2



TDI-P1

TPM Series Technical Specifications

TPM7.800

1600W PROGRAM / 800W RMS @ 4 Ohm

Total 10Ch Input: 6Ch / STEREO: 1Ch x 2TK: 2 Ch

3 band EQ on each channel / 2x7 band EQ

24 bit DSP -100 programs

Intelligent Auto Compressor

Built-in Side Handles

Dimension(LxWxH): 604 x 367 x 370 mm / 23.78" x 14.45" x 14.57"

Net Weight: 16.2 Kg / 35.72 lbs

TPM8.2000

2000W PROGRAM / 1000W RMS @ 4 Ohm

Total 12 Input: 6Ch / STEREO: 2Ch x 2TK: 2 Ch

3 band EQ on each channel / 2x9 band EQ

24 bit DSP -100 programs

Intelligent auto compressor

Built-in Side Handles

Dimension(LxWxH): 557 x 296 x 280 mm / 21.93" x 11.65" x 11.02"

Net Weight: 15.95 Kg / 35.16 lbs

TPM9.1000

2000W PROGRAM / 1000W RMS @ 4 Ohm

Total 14Ch Input: 6Ch / STEREO: 3Ch x 2TK: 2 Ch

3 band EQ on each channel / 2x7 band EQ

24 bit DSP -100 programs

Intelligent auto compressor

Built-in Side Handles

Dimension(LxWxH): 667 x 367 x 370 mm / 26.26" x 14.45" x 14.57"

Net Weight: 19.6 Kg / 43.21 lbs

TPM6250MKII

600W PROGRAM / 300W RMS @ 4 Ohm

Total 8 inputs

2 band EQ on each channel / 7 band EQ

24 bit DSP - 100 programs

Send and Return for External Processor,

Intelligent Auto Compressor

Dimension(LxWxH): 511 x 311 x 348 mm / 20.12" x 12.24" x 13.7"

Net Weight: 11.4 Kg / 25.13 lbs

TPM8250MKII

600W PROGRAM / 300W RMS @ 4 Ohm

Total 10 inputs

2 band EQ on each channel / 7 band EQ

24 bit DSP - 100 programs

Send and Return for External Processor,

Intelligent Auto Compressor

Dimension(LxWxH): 576 x 311 x 348 mm / 22.68" x 12.24" x 13.7"

Net Weight: 12.58 Kg / 27.73 lbs

Common features:

1 Expandable module bay, digital FX, Phantom Power switch, 12V lamp socket, 115V/230V switchable, all wood cabinet, retail ready packaging.

TOPP Modular Expandability Optional user installable modules:



MP3 USB T



MX DSP

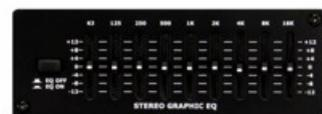

MX EQ

Maximizes the Value & Prolongs the life of your Investment

TPM Series

**BEST
SELLER**



digital fx

MAXHEB
POWER MODULE *Optimum Headroom & SPL*

600W PROGRAM STEREO **300W** RMS **CE** APPROVED
TOTAL SYSTEM POWER



8 CH INPUTS **TPM6250MKII**

600W PROGRAM STEREO **300W** RMS **CE** APPROVED
TOTAL SYSTEM POWER



10 CH INPUTS **TPM8250MKII**

1600W PROGRAM STEREO **800W** RMS **CE** APPROVED
TOTAL SYSTEM POWER



10 CH INPUTS **TPM7.800**

2000W PROGRAM STEREO **1000W** RMS **CE** APPROVED
TOTAL SYSTEM POWER



12 CH INPUTS **TPM8.2000**

2000W PROGRAM STEREO **1000W** RMS **CE** APPROVED
TOTAL SYSTEM POWER



14 CH INPUTS **TPM9.1000**



CREATIVE, INSIGHTFUL, VALUABLE...
ALWAYS RELIABLE!

www.topppro.com

Tropical Music Export Enterprises, Inc.
Exclusive Latin America Distribution

7091 NW 51 Street,
Miami, Florida, USA. 33166

Tel.: 305-740-7454
Fax: 305-740-7456

E-mail: sales@tropicalmusic.com

